

Side panels and flanges



Side Panels

For Ripac Vario, Ripac Vario EMC,
Ripac Compact, Ripac Vario Mobil
Mounting holes and anti-twist half-shears
on a 10 mm pitch pattern.

Material:

2.5 mm aluminium, clear-chromated



Custom versions available upon request.

U			Model No. RP									
			3	4 (3 + 1)	4 (3 + 2 x 1/2)	6	7 (6 + 1)	7 (6 + 2 x 1/2)	9	10	11	
D mm	a ¹⁾ mm	Packs of										
185	160	1	3684.511	–	–	3684.529	–	–	–	–	–	–
225	200	1	3684.512	3685.793	3685.890	3684.530	3685.896	3685.893	3685.797	–	–	–
245	220	1	3684.513	3685.850	3685.891	3684.531	3685.897	3685.894	–	–	–	–
285	260	1	3684.514	3684.523	3684.526	3684.532	3685.743	3685.895	–	–	–	–
305	280	1	3684.515	3685.794	–	3684.533	–	–	3685.798	–	–	–
345	320	1	3684.516	3684.524	3684.527	3684.534	3685.744	3685.745	3684.547	–	–	–
365	340	1	3684.517	3685.795	–	3684.535	–	–	3685.799	–	–	–
405	380	1	3684.518	3684.525	3684.528	3684.536	3684.541	3684.543	3684.548	3684.545	–	–
425	400	1	3684.519	–	–	3684.537	–	–	–	–	–	–
465	440	1	3684.520	3685.796	3685.892	3684.538	3684.542	3684.544	3684.549	3684.546	3684.552	–
525	500	1	3684.521	–	–	3684.539	3685.898	3685.959	3684.550	3685.899	3684.553	–
585	560	1	3684.522	–	–	3684.540	–	–	3684.551	–	3684.554	–

¹⁾ a = Distance between the first and last mounting hole

3U

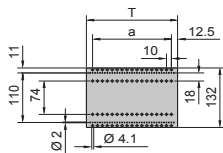

4U (3U + 1U)

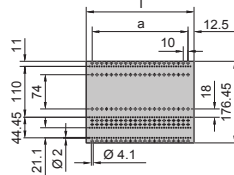

4U (3U + 2 x 1/2U)

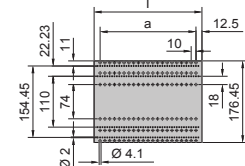

6U

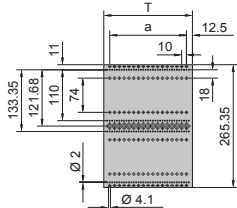

7U (6U + 1U)

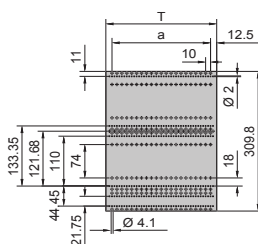

7U (6U + 2 x 1/2U)

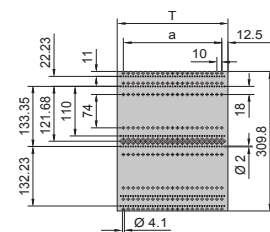

9U

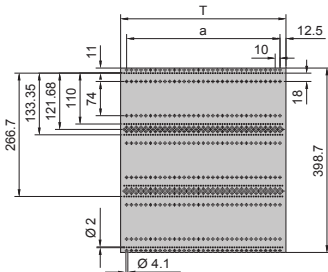

10U

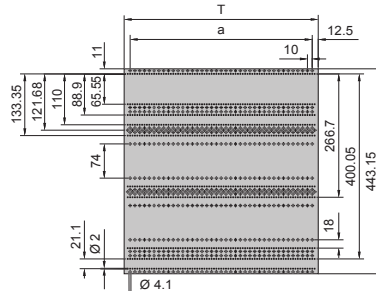

11U

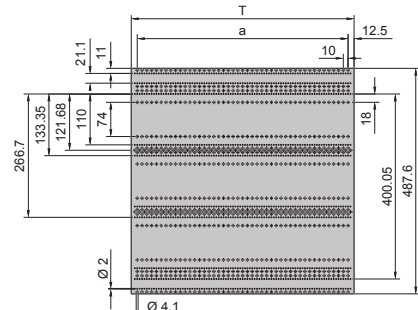

Side panels and flanges

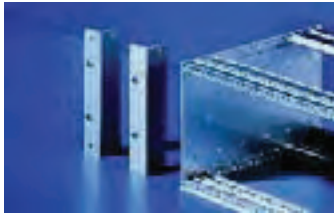

Flange 482.6 mm (19") flange

To fit all Ripac Vario, Ripac Vario EMC, Ripac Compact and Ripac Vario Mobil subracks. With integral channel to accommodate EMC gaskets.

Material:
Extruded aluminium section
Surface finish:
Clear-chromated

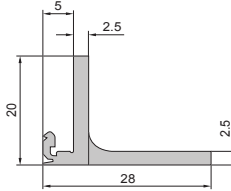
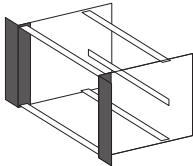

U	Packs of	Model No. RP	
		with handle holes	without handle holes
2	1	–	3684.614
3	1	3684.622	3684.615
4	1	3684.623	3684.616
6	1	3684.624	3684.617
7	1	3684.625	3684.618
9	1	–	3684.619
10	1	–	3684.620
11	1	–	3684.621

Custom versions available upon request.

Accessories:

EMC gaskets, vertical,
Handles for subracks.



Flange 482.6 mm (19") flange

Recessed
To fit all Ripac Vario, Ripac Vario EMC and Ripac Vario Mobil subracks.

Material:
Extruded aluminium section
Surface finish:
Clear-chromated

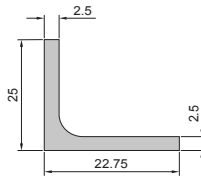
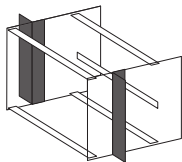

U	Packs of	Model No.	RP
3	1	3684.62	6
4	1	3684.62	7
6	1	3684.62	8
7	1	3684.62	9
9	1	3684.63	0
10	1	3684.63	1
11	1	3684.63	2

Custom versions available upon request.

Also required:

Assembly screws, nuts and washers.
Packs of 4 sets, Model No. RP 3687.015.



Side Panels for Ripac EASY

- Mounting holes spaced 60 mm apart as slots
- Holes for telescopic slide mounting

Material:
1.5 mm aluminium, corrosion-resistant

D mm	L2	n	n1	Packs of	Max. PCB depth mm	Model No. RP	
						3U	6U
175	–	–	–	2	160	3634.695	3634.720
235	60	–	–	2	220	3634.700	3634.725
295	60	2	2	2	280	3634.705	3634.730
355	60	3	3	2	340	3634.710	3634.735
415	60	4	3	2	400	3634.715	3634.740

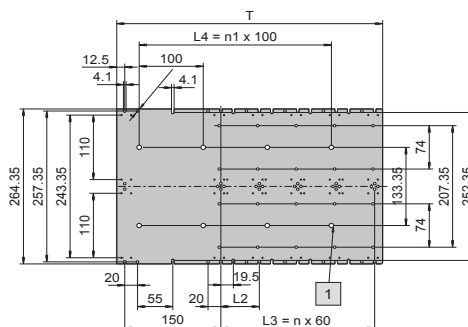
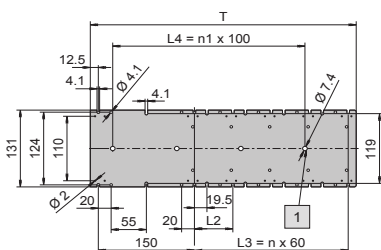

Custom versions available upon request.

Accessories:

Flange for Ripac EASY.