

5/8 ATR Chassis, Sealed with Airflow over Fins



ATR058-3U



KEY FEATURES

- 5/8 OpenVPX Top-loaded ATR enclosure for 3U OpenVPX / SOSA aligned boards
- Versions for 6U boards or hybrid 3U/6U available upon request
- Versions with standoff below backplane for VITA 66/67 interface cabling or shelf manager mezzanine
- Fully ruggedized with MIL-grade or commercial cabling for demo purposes
- Sealed conduction cooled enclosure with rear fans pulling airflow over extended external fins
- Various slot sizes at 1.0" pitch + VITA 62 PSU slot(s), consult Pixus for details
- Design options to 16 slots upon request
- 233mm H x 163mm W x 336mm D (standard, depth depends on slot number)
- 3U OpenVPX or custom backplanes
- Conduction cooled with external fans (contact Pixus for higher heat dissipation options—simulation to 800W has been performed)
- VITA 62 and specialty PSU options, MIL 704
- 12V, 5V, and 3.3V power outputs standard
- Customizable backplane I/O, cabling, and front

The ATR058-3U (formerly ATR058-HEX-3U) is a MIL-rugged ATR enclosure, available in development or deployable versions. Pixus leverages our library of OpenVPX / SOSA aligned backplane profiles to provide you with a solution to meet your requirements and minimize NRE costs.

Depending on your needs, Pixus will tailor the backplane I/O, cabling, and I/O to your specifications. An optional VITA 46.11 SOSA aligned shelf manager mezzanine behind the backplane is available. (It does NOT interfere with VITA 66/67 blocks/cabling in P2 of the backplane — see the datasheet in the Pixus OpenVPX Accessories section). The rear of the enclosure has fans (depending on cooling level required—application specific). The inside of the ATR is fully enclosed, while the outside shell pulls air through the sidewalls for enhanced cooling. Pixus has developed these enclosures in multiple slots sizes, consult Pixus for options.

POWER & COOLING

The ATR058-3U can employ various grades of PSUs. Typically VITA 62 / SOSA PSUs are utilized, up to 800W in 3U size. However, other PSU options are available. VITA 62 power supplies are designed for avionics and other MIL rugged applications and conform to MIL-STD-704, 461, and 810. There are also various options for AC or DC power feeds (typically 24-36VDC or 48VDC, or 90-264 VAC, etc.). Note that we typically load a higher power PSU than the max payload power for overhead and prolonging the MTBF. Dual 202 CFM/ea. MIL-grade fans are standard, but the fans are chosen per application. Commercial-grade fans are available for demo/development systems.

EXAMPLES—INTERNAL, REAR, SSD DOOR, AIR INTAKE, & FAN

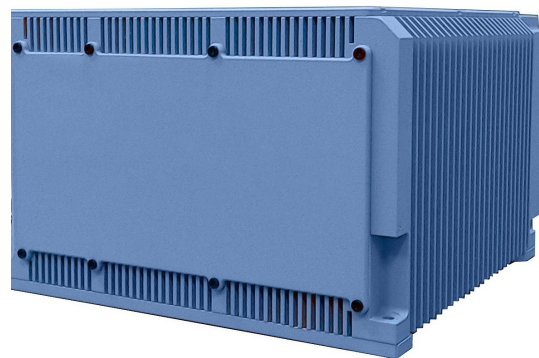
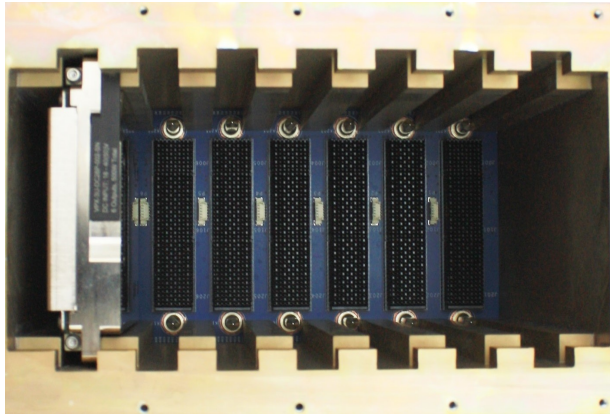

Pixus has various size, depth, and cooling orientation configurations for supplemental airflow over fins through the ATR's sidewalls. The company leverages standard COTS components and proven based platforms to tailor a solution for your specific application.

Other Sizes & Design Options

Longer and wider options of the ART058 are available upon request. Below are a couple of examples of thermal simulation of high wattage (including up to 800W) OpenVPX designs. Contact Pixus to discuss your application.

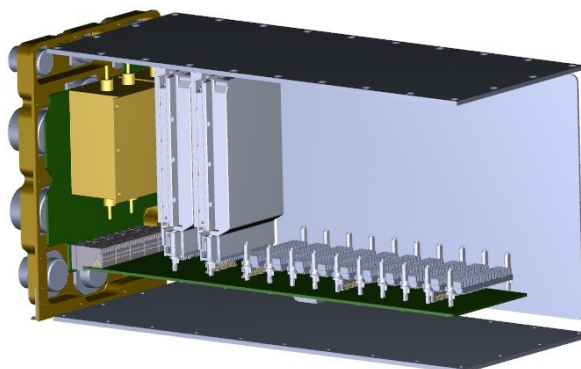
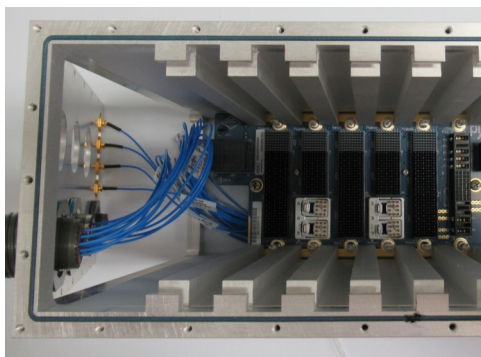
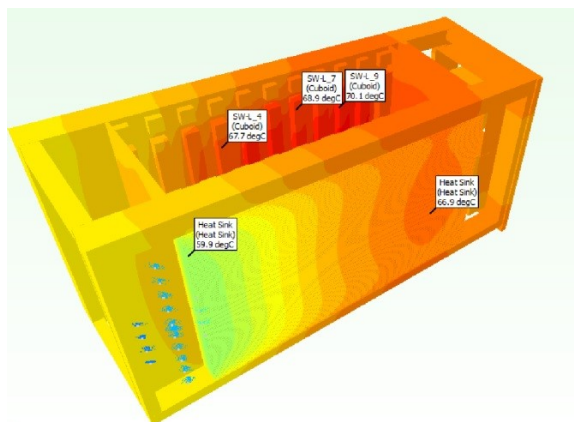
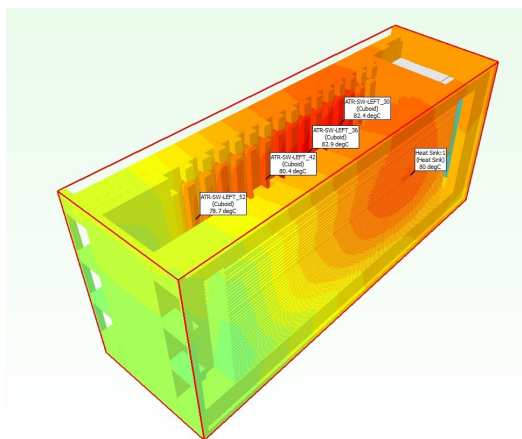

SOSA Aligned Slot Profiles

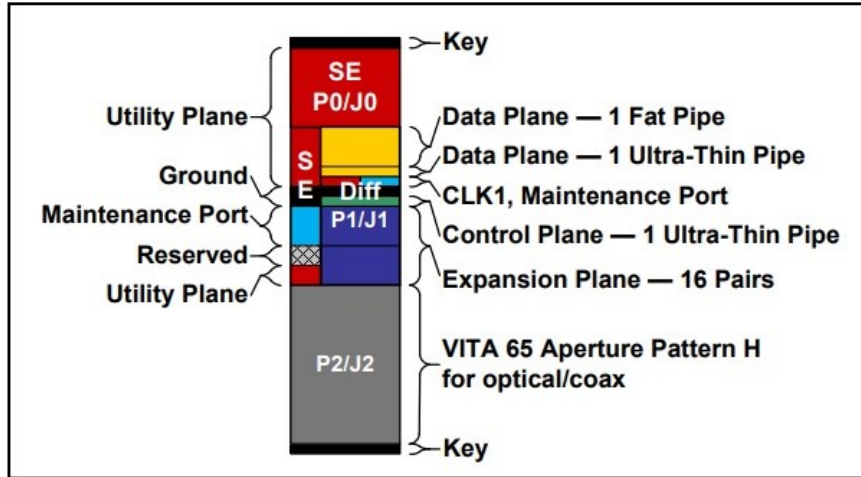

Figure 14.6.11-1 SLT3-PAY-1F1U1S1S1U1U2F1H-14.6.11-n

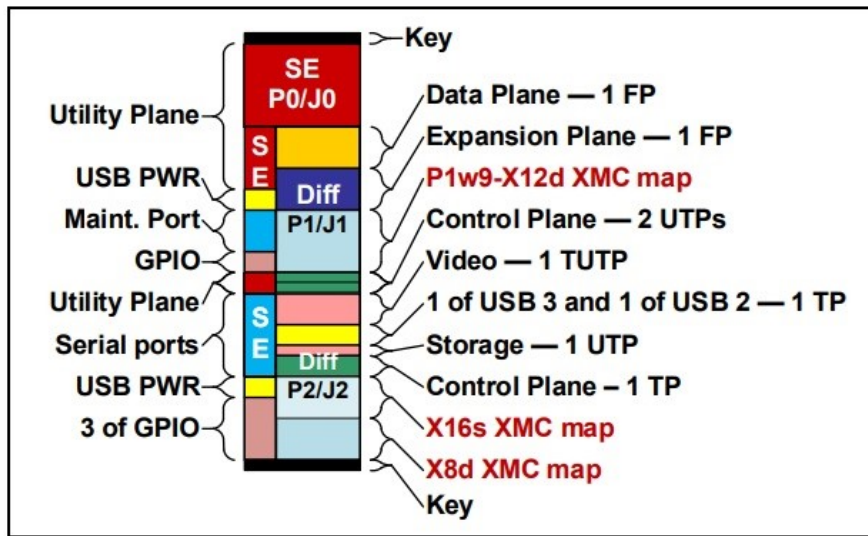

Figure 14.2.16-1 SLT3-PAY-1F1F2U1TU1T1U1T-14.2.16

Pixus has multiple backplane options that support various SOSA slot profiles. SOSA aligned systems utilize just the 12V (VS1) rail along with some 3.3 AUX. The IPMB is routed across the backplane to support the use of a SOSA aligned chassis manager and VITA 46.11 compliant versions. Visit <https://pixustechnologies.com/products/enclosure-system-solutions/vpx-vme64x-chassis-2/openvpx-3u-6u-sosa/> to see Pixus' offering of SlotSaver™ mezzanine-based and pluggable SOSA aligned/VITA 46.11 chassis manager options.

Examples of the wide variety of options are shown below. Several of the Pixus power and ground and routed backplanes have cutouts for Aperture H (VITA 67.3c) or other RF/Fiber sizes (Aperture J—VITA 67.3d, etc)

SPECIFICATIONS

Architecture		
Physical	Dimensions	Height: 233mm*
	Pitch	1.0" slot pitch standard, 0.85" optional
		Width: 163mm*, width may vary for cooling requirements, consult factory
		Depth: 336mm* for 7-slot version, various depth options, consult factory
	Weight	~ 17 lbs, dual fan configuration, cabling not included
Type	ATR chassis	*consult Pixus for other size options
Standards		
ARINC	Type	ARINC 404, 600
VITA/ANSI/SOSA	Backplane, Chassis	VITA 65 for OpenVPX (optional), VITA 48.x, SOSA Aligned options
MIL-STD	Type	810F (shock, vibration to 20G, environmental), 461F (EMI), 704 (power)
Configuration		
Power	Type	18-36VDC, 37-56VDC, 90-264VAC input @ 47-880Hz (consult Pixus for other options)
		Various output options (3.3V, 5.5V, +/- 12V)
Environmental	Temperature	Operating temperature: -40° to +71°C (application dependent)
		Storage temperature: -55° to +90°C
	Altitude	Application dependent, consult Pixus for details
Conformal Coating		Upon request (See page 4 selection "J" for available options)
Other		
MTBF	Varies, consult factory for details, MIL-HDBK-217A	
Certifications	Designed to meet FCC, CE and UL certifications where applicable	
Standards	ISO9001:2015	
Compliance (DTM)	MIL-STD-810, MIL-STD-461, DO-160	
Warranty	Two years	
Trademarks and logos	The Pixus Logo is a registered trademark of Pixus Technologies Inc. other registered trademarks are the property of their respective owners. Specs. subject to change without notice.	

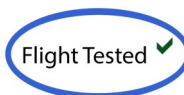

(Previously ATR058-HEX prefix)

ORDERING OPTIONS

ATR058-ABCCD-EFG-JK

A = Backplane

- 1 = 3U OpenVPX / SOSA (standard)
- 2 = Other

B = Backplane Speed

- 1 = 6.25 Gbps
- 2 = 8 Gbps (for PCIe Gen3)
- 3 = ~10 Gbps (for 40GbE)
- 4 = Other
- 5 = ~25 Gbps (for 100 GbE)

CC = Payload Slots (Not including PSUs)

- Example 0n = n slots
- 01 = 1 slot
 - 02 = 2 slots

- 03 = 3 slots
- 09 = 9 slots

D = PSU Slots

- 1 = 1 VITA 62 / SOSA slot (standard)
- 2 = 2 VITA 62 / SOSA slots
- 3 = Other

E = PSU Input

- 1 = 24-28V DC
- 2 = 48V DC
- 3 = 90-230V AC
- 4 = Other

F = PSU Type

- 1 = VITA 62 / SOSA to 400W
- 2 = VITA 62 / SOSA to 500W
- 3 = VITA 62 / SOSA to 850W
- 4 = VITA 62 / SOSA to 1000W
- 5 = Other

G = Cooling

- 1 = Sealed with heat exchange (standard)
- 2 = Sealed with heat exchange, fan(s) not installed

J = Conformal Coating

- 0 = None
- 1 = Humiseal 1A33 Polyurethane
- 2 = Humiseal 1B31 Acrylic

K = Finish/Coating

- 0 (or Blank) = Clear chromate finish (standard)
- 1 = Painted (contact Pixus for options)
- 2 = Anodized (external only)