

PRODUCTS SERVICES



• RACKMOUNT & RUGGED SYSTEMS

• CASES, SUBRACKS, & RITTAL
BRAND COMPONENTS



About Pixus Technologies

Pixus Technologies utilizes our extensive experience in embedded computing systems and electronics enclosures to provide the best solution for our customers at highly competitive prices. With a mix of in-house development and leveraging proven, time-tested designs from key partners, you receive the best-of-the-best of all elements of a system that meets your specifications and budget constraints.

Leveraging sleek European quality mechanical designs from Rittal and other key partners, Pixus is able to offer time-tested embedded computing system platforms and electronics enclosures at highly competitive prices. Rittal is the largest manufacturer for enclosures in the world.

Pixus provides unsurpassed thermal management solutions, creative design innovations, backplane design and subsystem integration expertise. This powerful combination results in the premier value in the industry for electronics packaging. The company offers backplane designs, chassis platforms, and board-level products in OpenVPX, AdvancedTCA, MicroTCA, and custom architectures. Legacy architectures such as CompactPCI and VME/64x are also available. Additionally, Pixus provides a vast ecosystem of embedded components including ejector handles & panels, card guides, rails, subracks, instrumentation cases and more. In May 2011, Pixus Technologies became the sole authorized North and South American supplier of the electronic packaging products previously offered by Kaparel Corporation and Rittal.

Benefits of Choosing Pixus Technologies

- Manufacturing/integration resources in Canada, USA, Asia, and Europe
- Established 2010 at Head Quarters in Waterloo, Ontario (Canada's Technology Corridor)
- Superior, dedicated service
- Excellent quality & reliability
- Nimble approach means best & most cost-effective solution
- Engineering expertise in electrical, mechanical, and integration
- Privately owned and financially stable
- ISO9001:2008 certified and ITAR registered

Pixus Timeline

The name "Pixus" is derived from the companies roots going back to 1996.

Many of the key staff, including the founders were Pixstream/Kaparel employees going back nearly 20 years.

1996 – Pixstream is founded

1999 – Pixstream spins off Kaparel

2001 – Kaparel acquires Jardon Engineering

2002 – Rittal Corporation acquires Kaparel

2010 – Rittal closes North American operation

2010 – Pixus is founded, exclusive supplier of Rittal products in North America

2012 – Pixus offers customized chassis platform and backplane solutions, includes MIL/Aero offering

2015 – Pixus expands from Level 3 to Level 4 integration

Pixus Technologies

50 Bathurst Dr.

Waterloo, Ontario N2V 2C5

Phone: 519 885 5775

Fax: 226 444 0225

sales@pixustechnologies.com

info@pixustechnologies.com

www.pixustechnologies.com

East Coast

Smithtown, NY

Phone: 631 360 1257

West Coast

Sacramento, CA

Phone: 916 297 0020



Table of Contents

About Pixus Technologies	2
OUR PRODUCTS	6
OUR SERVICES	8
CUSTOMER SERVICE	10
The Optimum Service Process	13
Benefits	15
Industries	16
Rugged & Rackmount Products	17
OpenVPX Systems	18
OpenVPX Chassis	19
OpenVPX Backplanes	22
OpenVPX Customized Design Service	23
OpenVPX System Platform Customized Design Service	24
OpenVPX Accessories	25
OpenVPX Backplanes	26
OpenVPX Boards	27
About AdvanceTCA	29
AdvancedTCA Shelves	30
AdvancedTCA Overview	31
Shelf Managers	32
ATCA	33
About MicroTCA	35
MicroTCA Enclosures	36
MicroTCA Modules	37
Other 19" Rackmount Architectures Overview	38
Laboratory Equipment	41
Rackmount Systems for cPCI	42
cPCI - Slim-Box Vario	43
cPCI - Rackmount systems, Ripac 4U/7U, 8 slots	46
cPCI - Rackmount systems, Ripac 9U, 8 slots, with RiCool radian fan	48
cPCI - Backplanes, Technical Specifications	49
cPCI - Backplanes	51
cPCI - Power Supply Boards	57
cPCI - Backplanes, Horizontal	58
VME64x - Rack-mount Systems, Slim-Box Vario 2U, 4U	59
VME64x - Rackmount Systems, Ripac 3U, 5 lots/4U, 7 slots Horizontal	60
VME/VME64x - Rackmount Systems, Ripac 4U/7U, 12 slots	61
VME/VME64x - Rackmount Systems, Ripac 7U, 12 slots, with RiCool radial fan	63
VMEbus - Backplanes, Technical Specifications	64
VME64x - Backplanes VME64x	66
VME - Backplanes VME	67
Power Supplies	70
Power Supplies Overviews	71
Power Supplies for VME, plug-in	74
Ripac Power Supplies	75
cPCI Power Supplies	76
ATX Power Supplies	77
Rugged Enclosures Overview	78
Rugged Enclosures	79
Climate Control for Subracks	80
Cool Solutions	88
Rittal Ripac	89
Subrack Climate Control - Conventional AC/DC Tubeaxial Muffin Fans	92
Subrack Climate Control - Rackmounted fan 482.6 mm (19")	93

Enclosures, Subracks	95
Pixus Technologies Subrack Systems	96
Pixus Basic Subrack Systems - Overview	97
Subracks Ripac EASY	100
Ripac Vario 3U, 6U, 9U	102
Ripac Vario 4U, 7U	103
Ripac Vario EMC 3U, 6U, 9U	104
Ripac Vario EMC 3U, 6U, 9U	105
Ripac Compact 3U, 6U	106
Ripac VarioMobil 3U, 6U	107
Table of Horizontal Rails	108
Subracks, Individual Componets - Side Panels and Flanges	110
Horizontal rails	113
Horizontal rails for Ripac EASY	114
Subrack Accessories	124
Components for EMC Installation	125
Mounting Kits	126
Guide rails	127
Keying/PCB ejectors	132
Covers for Subracks	133
Front Panel Service: Subrack Accessories	138
Front Panels, Handles	139
Injector/Extractor Handles	142
Subracks Front panels	143
Subracks Injector/ Extractor Handles	144
Ripac Box Type Plug-In Units - Individual Components	155
Ripac box type plug-in units – type I	156
Ripac Box Type Plug-In Units - Individual Components	157
Assembly Parts	159
Ripac Vario-Module System Enclosure	161
Instrument Cases/System Enclosures	162
RiBox System Enclosures 1U	163
Ripac Vario-Module 2U	164
Ripac Vario-Module 2U, EMC	165
Ripac Vario-Module 3U	166
Ripac Vario-Module 3U, EMC	167
Ripac Vario-Module 4U, 6U, 7U	168
Ripac Vario-Module 4U, 6U, 7U, EMC	169
Ripac Vario-Module Accessories	170
RiCase 269.2mm (1/2 19")	173
RiCase 482.6mm (19")	174
RiCase Accessories	175
Technical Details	183
Power supplies	185
Subracks	186
Instrument cases/system enclosures	191
Subracks	193
EMC diagram for Ripac Vario EMC	194



European Quality Sensibly Priced

- High quality German and North American designs
- Low-cost manufacturing at top enclosure center in the world, superior quality and consistency
- Customization expertise, lower volumes accepted
- Focus on superior service and ontime delivery
- ITAR-compliant, Mil/Aero expertise

In May 2011, Pixus Technologies became the sole authorized North and South American supplier of the electronic packaging products previously offered by Kaparel Corporation and Rittal.



Product Overview

Our Products

Pixus offers products in two main classes – “Rackmount & Rugged Solutions” for embedded computing systems and products and “Cases, Subracks, and Rittal Brand Components” for instrumentation cases and electronics enclosure/embedded components.

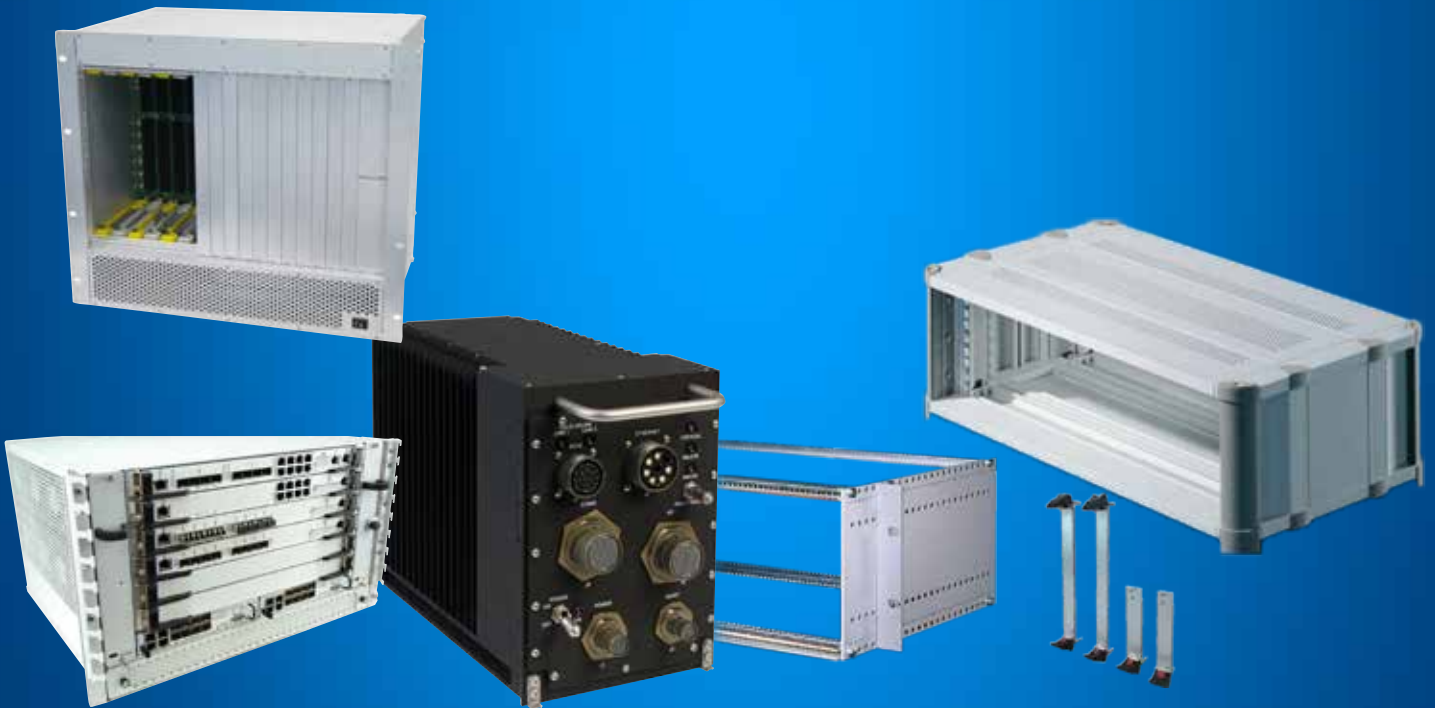

Rackmount & Rugged Solutions

From chassis platforms, to backplanes, to boards, Pixus offers a virtually unlimited array of high quality embedded computing solutions. Pixus specializes in open-standard backplane architecture designs. This includes OpenVPX, MicroTCA, CompactPCI Serial, and AdvancedTCA. The company also offers ruggedized and small form factors solutions such as VNX, ATR enclosures, and application-specific designs. Legacy VME and CompactPCI designs are also supported.

Cases, Subracks, and Rittal Brand Components

From chassis platforms, to backplanes, to boards, With over 100K components, Pixus’ design experts can configure virtually unlimited configurations to open-standard COTS computing architectures. A vast offering of high quality European-design components include card guides, ejector handles/panels, extruded rails, side walls, and accessories.



Experience You Can Trust

Leveraging Rittal's sleek European quality mechanical designs, Pixus is able to offer time-tested embedded computing system platforms that are built in one of the largest manufacturing centers for enclosures in the world.

With Pixus' subsystem integration expertise, the result is the premier value in the industry for electronics packaging. Pixus offers backplane designs and chassis platforms in OpenVPX, CompactPCI, AdvancedTCA, MicroTCA, VME/64x, and custom architectures. The company also provides a vast ecosystem of embedded components including ejector handles & panels, card guides, rails, subracks, and more.

Customization

Modular Products Tailored to your Specific Application

Our Services

Pixus Technologies' services include customization, creative design, thermal simulation, signal integrity simulation/test, and more. Our expertise from specialization in backplane design to mechanical precision, to detailed knowledge of embedded systems gives us unique perspective to offer creative solutions.

Thermal Simulation

Using thermal analysis software and test equipment, Pixus is able to provide thermal management analysis of the enclosures

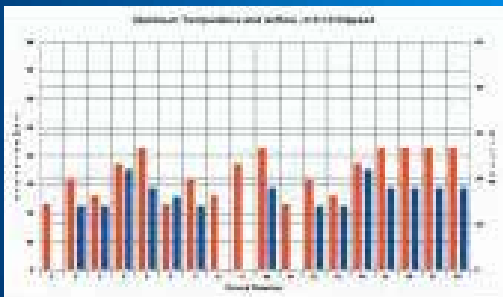

Modified Standards and Customization

Pixus Technologies' focus allows our customers to supply the application while we provide a reliable architecture solution on time.

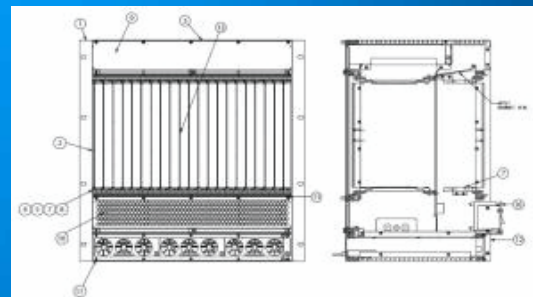

Front Panel Customization and Assemblies

Services for the front panels include custom design, stamping/milling, painting/silkscreening, assembly and single part number ordering. Contact Pixus for custom handle/panel services.

Backplane Simulation/ Characterization

Pixus Technologies can perform pre-design simulation and post-design characterization testing to confirm superior backplane performance.

Pixus electronic packaging – a spectrum of services for individual, complete packages. Pixus's modular, mass-produced system components enables us to achieve the optimum individual solution for every client, quickly and cost effectively. Complete solutions, with no ifs or buts.

The extensive Pixus range, including climate control components, control and monitoring technology, system accessories and hardware components such as power supplies, is at your disposal. System integration offers a wealth of benefits: Only one project partner, significantly reduced planning and assembly work, and minimal logistics and procurement input.

Pixus electronic packaging – simple, perfect and complete.



People are at the heart of all communications. They plan and organise, initiate and control. The IT infrastructure also has a decisive effect on their efficiency and success.

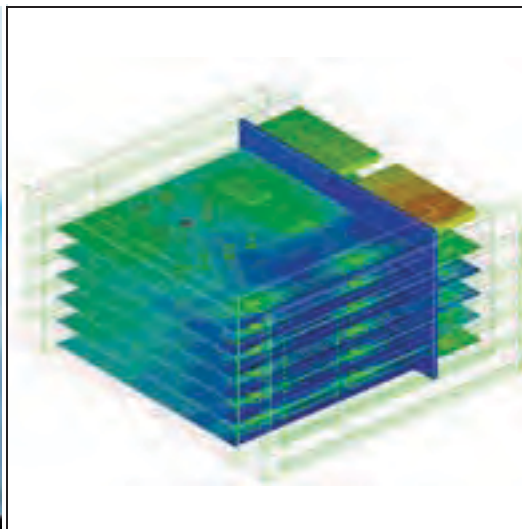

CFD enables us to optimise climate control solutions long before the first prototype has been built. The Pixus portfolio of services includes:

- Visualisation of temperature variations
- Visualisation of air flows
- Localisation and elimination of heat accumulation and hotspots
- Targeted optimisation of climate control
- Positioning of temperature sensors and smoke alarms.



All our products reflect the latest technical findings, and conform to globally recognised quality standards with certifications, and internationally valid approvals. Our comprehensive Total Quality Management system ensures consistently high product quality worldwide. All requirements are on a partnership basis, at both global and local levels.

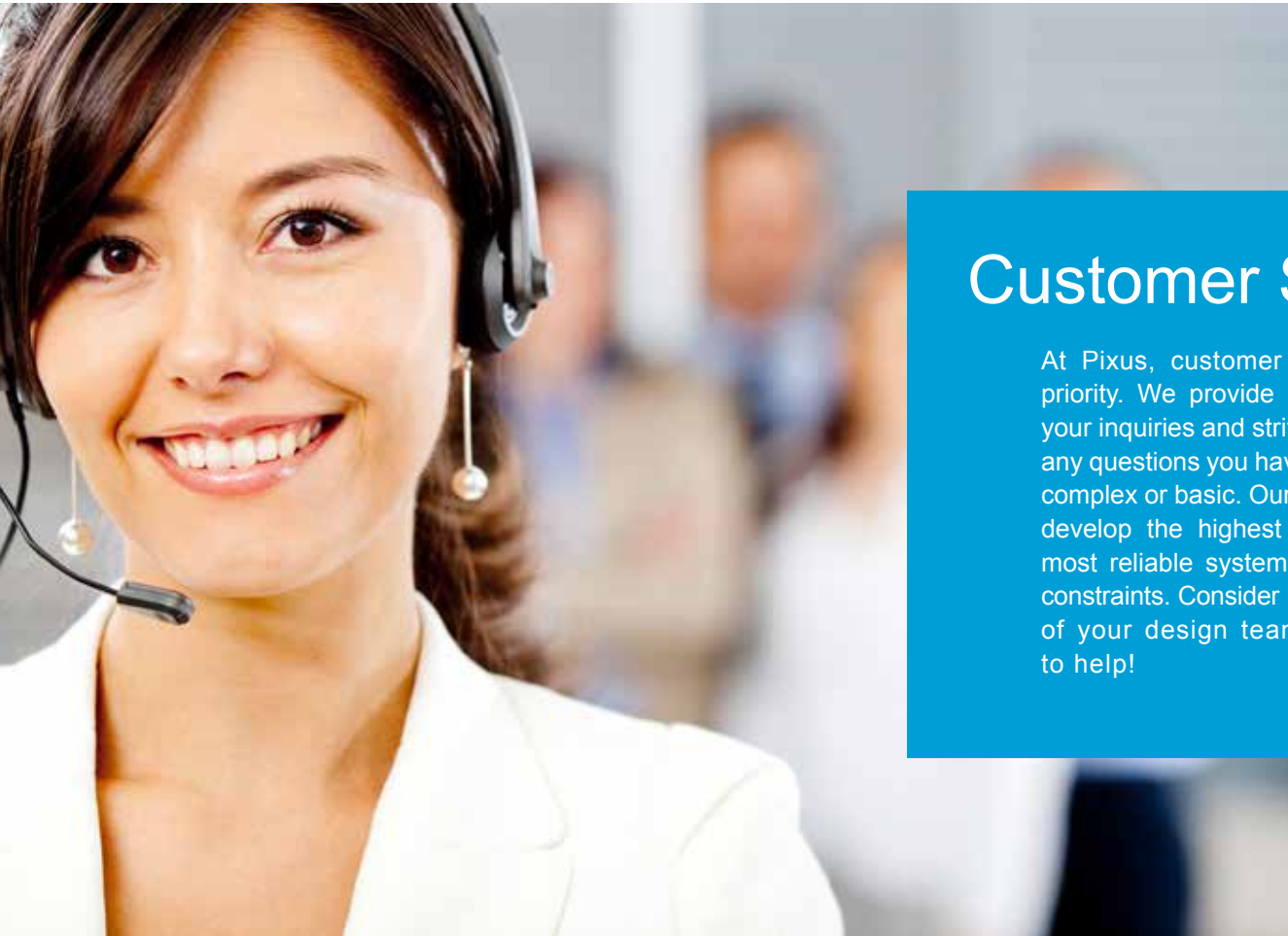

Customer Service

At Pixus, customer service is a top priority. We provide rapid response to your inquiries and strive to help you with any questions you have – no matter how complex or basic. Our role is to help you develop the highest performance and most reliable system with your budget constraints. Consider Pixus an extension of your design team – we are here to help!

Boost your efficiency with our product expertise





The Optimum Service Process

Rather than individual components, there is a growing demand for fully integrated plug & play system solutions. In order to ensure individual, high-quality solutions, Pixus subjects every product to a defined service process.

Particularly during the development phase, the result is optimised through continuous contact and exchange.

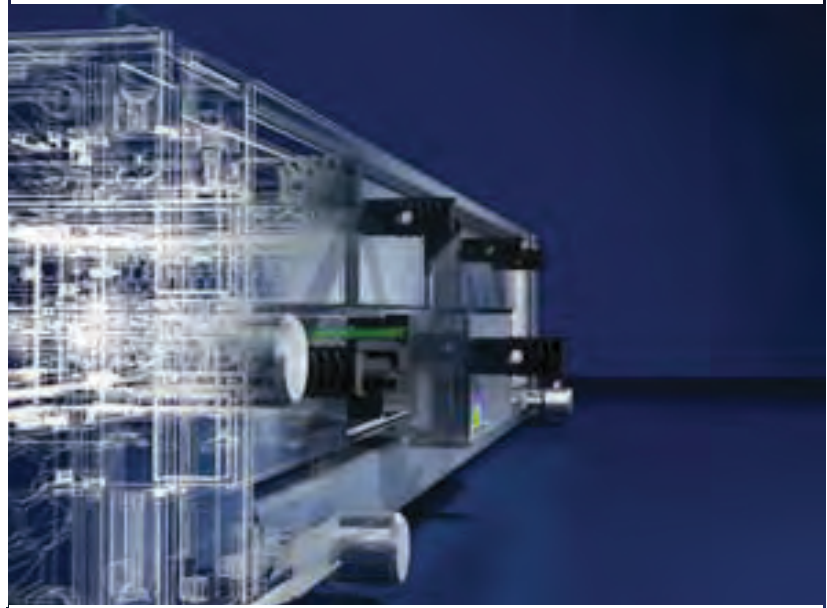

Project planning

Application engineering

Prototyping

Project planning

Precise analysis of requirements according to relevant factors such as location, function and technical status – the basis for sound advice.

Application engineering

Our application consultants will guide you to the most efficient solution. All key questions relating to the system and components, as well as specific market conditions, are clarified. Simulations for the areas of climate control, mechanics and backplane help to highlight any problem areas and enable their solution.

Prototyping

Once the electronic packaging concept has been agreed, a prototype is prepared. In intensive dialogue with you, the prototype is optimised to your precise requirements.

Pixus system integration up to Level 4

This is the cumulative result of extensive in-depth consultations and precision planning, e.g. with climate control, power supply and security management through to Level 4 system integration.

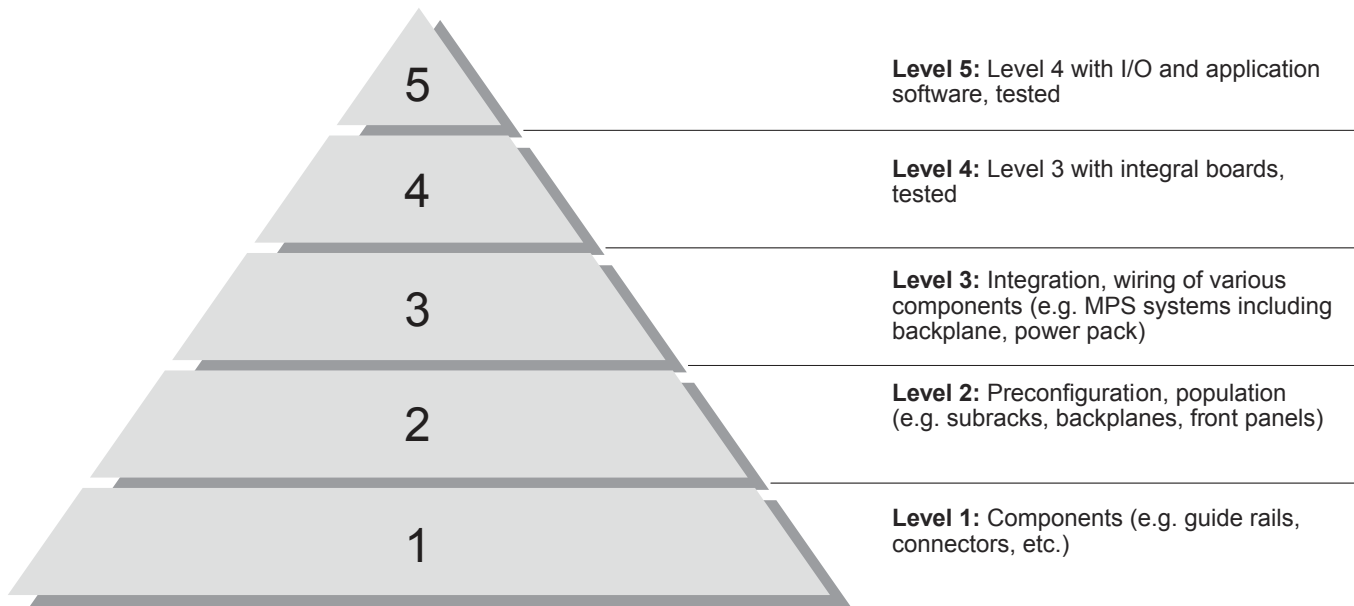

Testing

Mass production

After-sales service

Testing

A comprehensive test and check programme is carried out at our accredited Pixus test laboratory. Mechanical load capacity, dust and humidity protection are exhaustively tested, as are other factors such as extreme climate conditions. Your advisor will notify you immediately of the outcome of all these tests and checks. Any optimisation requirements are defined, implemented and then subjected to retesting.

Mass production

Once a suitably high level of functional reliability has been achieved, serial production can begin. Prior to delivery, every system undergoes the full range of functional and safety checks.

After-sales service

We continue to assist you with on-site advice and support. In this way, you can draw on our expertise, and we are happy to answer your questions at any time.



BENEFITS

- High quality German and North American designs
- Low-cost manufacturing at top enclosure center in the world, superior quality and consistency
- Customization expertise, lower volumes accepted
- Focus on superior service and on-time delivery
- ITAR-compliant, Mil/Aero expertise

Industries

Military / Aerospace



Broadcast



Transportation



Energy / Industrial



Communications



Medical



Test & Measurement



Research / Lab

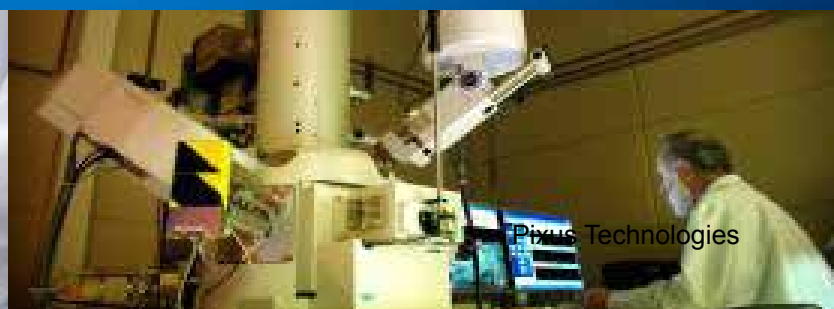

Rugged & Rackmount Products

Pixus' design experts can configure virtually unlimited configurations to open-standard COTS computing architectures. We offer backplane designs, chassis platforms, and board-level products in OpenVPX, AdvancedTCA, MicroTCA, CompactPCI Serial, legacy VME/CompactPCI and custom architectures. From individual components to complete integrated systems, Pixus has a solution for you.

Pixus also offers rugged rackmount, ATR, and specialty Small Form Factor (SFF) chassis platforms and systems designed for military/aerospace and other rugged applications. From rackmount air-cooled systems to application specific conduction-cooled designs, we have a solution for you. The company also provides various board-level products and integration options.

Specialists in high-speed backplane design to 100G and beyond

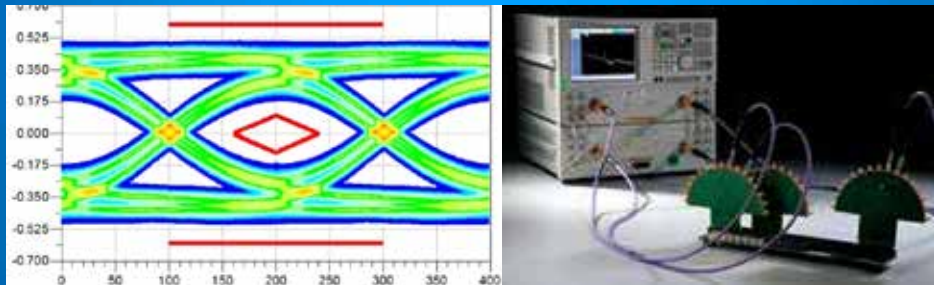

Experts in creative cooling solutions

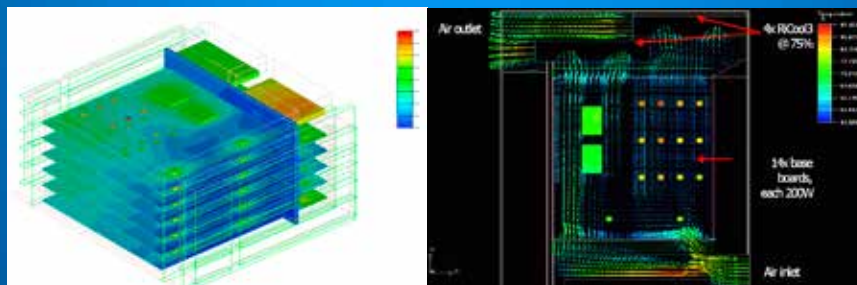

Unique designs with space for RF devices, other components

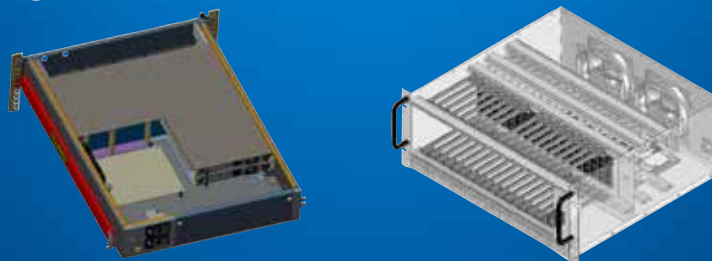

OpenVPX Systems



OpenVPX is a high-speed serial platform used in Mil/Aero and other applications. The Eurocard-based form factor features 3U and 6U boards that are used in rugged or COTS enclosure platforms that are forced air cooled or conduction cooled. The high-speed architecture has backplane and board “profiles” per VITA 65 to ensure interoperability. VITA 65 is an extension of VITA 46 to ensure compatibility.

Pixus has a virtually unlimited array of configuration options for 19” rackmount VPX Eurocard-based enclosures and a wide selection of rugged/ATR system platforms. We also provide configuration selection and integration services. As backplane experts, Pixus has a wide variety of standard backplane configurations/profiles as well as cost-effective customized solutions.



OpenVPX Chassis



Compliant to the VITA 46 specification for VPX (with VITA 65 OpenVPX compliant backplanes), Pixus offers complete systems with power supply unit and backplane, fully assembled, pre-wired and tested. With a modular design approach, Pixus can offer virtually unlimited VPX chassis configurations for 3U and 6U boards. The VPX enclosures come in 1U-4U horizontal-mount (for 6U boards), 4U-5U vertical-mount (for 3U cards), and 7U, 9U, and higher chassis (for 6U OpenVPX boards).





OpenVPX Chassis for 6U Boards, Vertical

Chassis Height	Depths	Width	Slots	Cooling Configuration	Part Number Prefix
7U	~ 11 in, modifiable	19" rackmount external, ~16.8" internal	2-21 (17 slots max if 1" pitch)	Bottom-to-top	VPX7U160
9U	~ 11 in, modifiable	19" rackmount external, ~16.8" internal	2-21 (17 slots max if 1" pitch)	Front-to-rear	VPX9V170



OpenVPX Chassis for 6U Boards, Horizontal

Chassis Height	Depths	Width	Slots	Cooling Configuration	Part Number Prefix
1U	~300mm	19" rackmount external, ~16.8" internal	2, (1 slot if 1" pitch)	Side-to-side	EUR191
2U	~300mm	19" rackmount external, ~16.8" internal	4, (3 slots if 1" pitch)	Side-to-side	EUR192
3U	~300mm	19" rackmount external, ~16.8" internal	6, (5 slots if 1" pitch)	Side-to-side	EUR193
4U	~300mm	19" rackmount external, ~16.8" internal	8, (6 slots if 1" pitch)	Side-to-side	EUR194

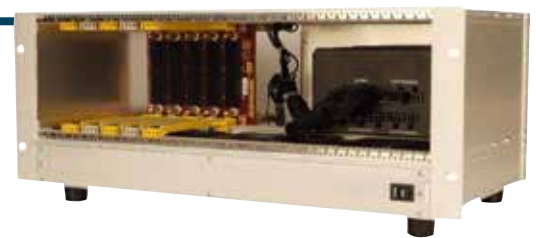

OpenVPX Chassis for 3U Boards, Vertical

Chassis Height	Depths	Width	Slots	Cooling Configuration	Special Features	Part Number Prefix
4U	~ 11 in, modifiable	19" rackmount external, ~16.8" internal	2-21 (17 slots max if 1" pitch)	Bottom-to-top		VPX4V180
5U	~ 11 in, modifiable	19" rackmount external, ~16.8" internal	2-21 (17 slots max if 1" pitch)	Front-to-Rear	Powerful 191 CFM (each) Reverse Impeller Blowers	VPX5V180



OpenVPX Open Frame Development Chassis

Chassis Height	Depths	Width	Slots	Cooling Configuration	Special Features	Part Number Prefix
9U	TBD	42 HP, modifiable	10, (8 slots max if 1" pitch)	Bottom-to-top		VPXD0800
10U	TBD	42 HP, modifiable	10, (8 slots max if 1" pitch)	Bottom-to-top	Removable sidewalls, fan speed control	VPXDR800

Rugged OpenVPX ATRs and Conduction-Cooled Systems

(See Rugged Section - page 78)

Notes:

- All chassis have RTM options
- Backplane speeds are 3.125, 5.0, 6.25, and 10 Gbps or custom
- FR-4 material for 3.125 speeds, higher speeds require higher grade materials

PSU Types -- all offer standard VPX voltages

- 400W Nevo
- 600W UltraMod
- 1200W UltraMod
- 500W VITA62 compliant
- 800W VITA62 compliant
- 1000W VITA62 compliant
- 500W ATX for some Development systems
- Other options available

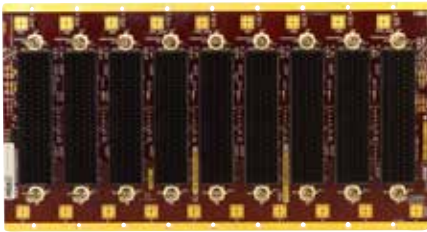

3U

Slots	Height (in mm)	Width (in mm)	Standard Profile	Part Number Prefix
3	128.4	73.16	CEN03-15.2.9	VPX30-03AA
5	128.4	113.80	DIS05-15.2.13	VPX30-05BA
6	128.4	134.12	DIS06-15.2.7	VPX30-06BB
6	128.4	134.12	DIS06-15.2.14	VPX30-06BC
9	128.4	195.08	N/A	VPX30-09XX
18	128.4	377.96	N/A	VPX30-18XX

Material:

Dependent of speed requirement, FR-4 standard. Nelco4000-SI typical for higher speeds (above 5.0 Gbps).

Supply includes:

Backplane, fully populated

Other slot sizes available - consult Pixus

RTM connector options available

M4 threaded studs standard, other power options optional

Optional monolithic backplanes with integrated VITA 62 PSU slot(s)

Approximate, consult factory for details



6U

Slots	Height (in mm)	Width (in mm)	Standard Profile	Part Number Prefix
2	262.19	52.84	DIS02-11.2.8	VPX60-02BA
5	262.19	113.80	DIS05-11.2.16	VPX60-05BB
6	262.19	134.12	DIS06-11.2.15	VPX60-06BC
8	262.19	174.76	HYB08-11.2.12	VPX60-08CA
9	262.19	195.08	CEN09-11.2.3	VPX60-09AA
10	262.19	215.40	CEN10-11.2.6	VPX60-10AB
10	262.19	215.40	CEN10-11.2.6	VPX60-11AC
17	262.19	393.20	HYB17-11.2.11	VPX60-12CB

Material:

Dependent of speed requirement, FR-4 standard. Nelco4000-SI typical for higher speeds (above 5.0 Gbps).

Supply includes:

Backplane, fully populated

Other slot sizes available - consult Pixus

RTM connector options available

M4 threaded studs standard, other power options optional

Optional monolithic backplanes with integrated VITA 62 PSU slot(s)

Approximate, consult factory for details

OpenVPX/VXS Backplane Testing

Features:

- MultiGig RT2 7-Row right angled plug connector
- 16 differential pairs + one double length thru connection for proper De-embedding
- 1,5mm Nelco 4000-13, 6-Layer PCB
- Three different test cards suitable for all Backplane measurements
- Performance optimized SMA and press fit connector footprints

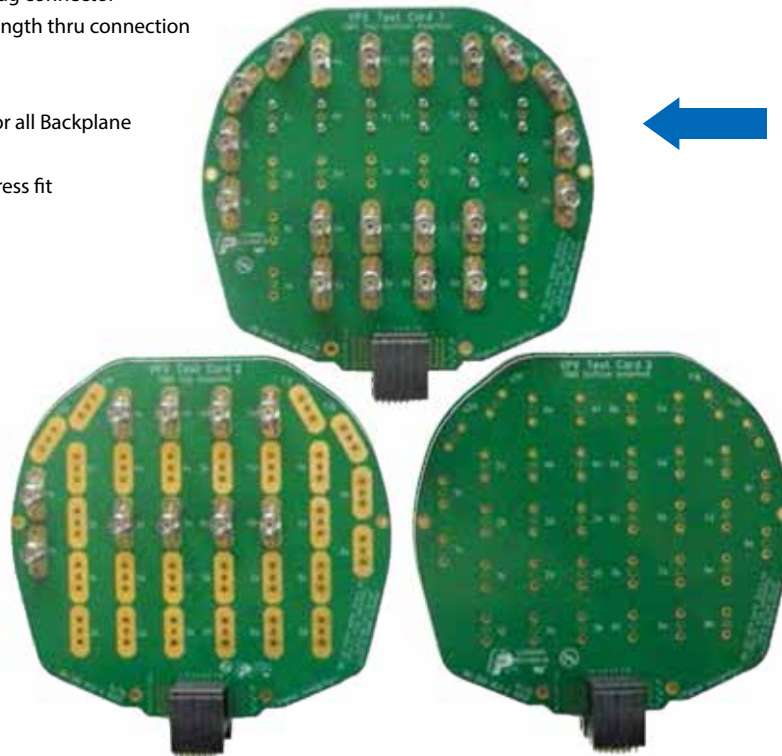

Test Card 1: SMA connectors mounted from top and bottom side if space is not a problem

Test Card 2: SMA connectors mounted from top side to access from the right side of the connector-backdrilling is used to minimize stub effect

Test Card 3: SMA connectors mounted from bottom side to get access from the right side of the connector-backdrilling is used to minimize stub effect

OpenVPX Product Series

Signal Integrity Services

Services

- System and Component Testing
- Simulation and Modelling
- Test Fixture Design
- Design Support
- Compliance Testing

Simulation and Modelling

- Full 3D Simulation
- Calculation of Field-Distribution
- Interconnect Simulation Models
- Channel Simulations
- RFID Antenna Design

Testing

- Frequency-Domain Measurements
- S-Parameter Analysis
- Interconnect Channel Characterization
- Time-Domain Measurements
- Signal Propagation Characteristics (TDR, Skew, Crosstalk, etc.)
- Eye Analysis

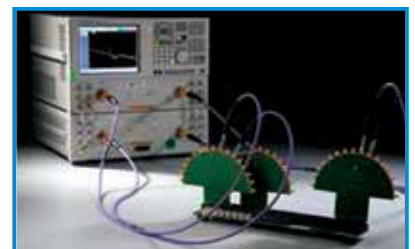
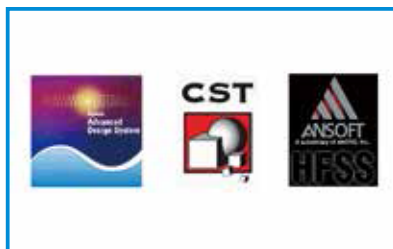

● **Signal Integrity Software and Test Equipment:**

Agilent N1955B Physical Layer Test System (PLTS)	
E8363B	Vector Network Analyzer
-PNA N4420B	Test Set
-N1930A	Software – Version 5.000
Tektronix TDS8200 Digital Sampling Oscilloscope	
2 x 80E04 Sampling Module	
2 x Sampling Module Extender Cable (1 meter)	
3D Simulation	
CST Studio Suite	3D full wave FIT Simulation
ANSYS HFSS	3D full wave FEM Simulation
ANSYS Q3D / Q2D	3D / 2D static BEM Simulation
ANSYS Optimetrics	Optimizer
Circuit- / Channel Simulation	
AGILENT Advanced Design System (ADS) High Speed Analog Designer Pro	
HSPICE	

OpenVPX Accessories

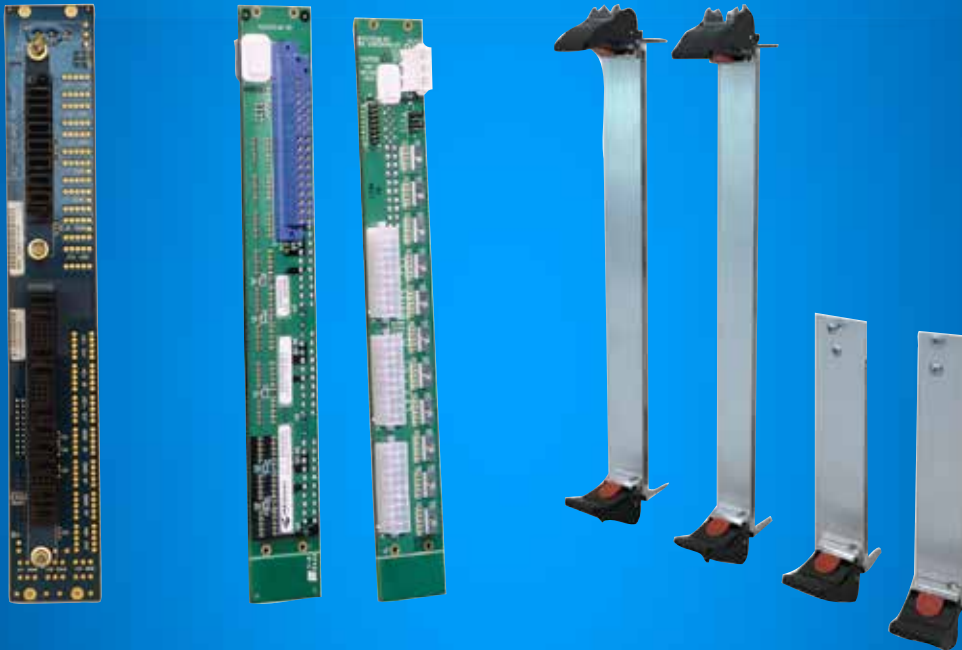

Pixus offers a wide range of accessories used in OpenVPX test & development systems including chassis managers, power interface boards, and more.

- 3U and 6U VITA 62 Power Interface Boards – see page 26
- 3U and 6U 47-pin Power Interface Boards – see page 55
- OpenVPX Handles/Panels – see page 143, 153 -154
- Chassis Managers per VITA 46.11, Other – see page 32



VITA 62 Power Interface Boards

Height	Type	Width	Part Number Prefix
3U	Single	4HP (0.8")	PIBV62-1A
3U	Single	5HP (1.0")	PIBV62-1B
3U	Double	8HP (1.6")	PIBV62-1C
3U	Double	10HP (2.0")	PIBV62-1D
6U	Single	4HP (0.8")	PIBV62-2A
6U	Single	5HP (1.0")	PIBV62-2B
6U	Double	8HP (1.6")	PIBV62-2C
6U	Double	10HP (2.0")	PIBV62-2D

Optional monolithic backplanes with integrated VITA 62 PSU slot(s)
 Approximate, consult factory for details

Other Power Interface Boards available -- see page 55

OpenVPX Boards

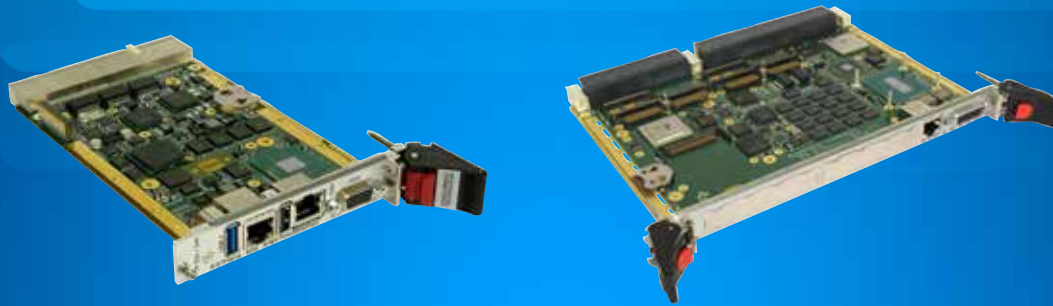

Configuring OpenVPX systems can be tricky. Utilize Pixus' expertise in selecting the right VPX modules for your application. With our key partnership, Pixus can help you find the right boards at the right price. For simplicity, you can order your full OpenVPX system and boards through Pixus or we will refer you to the best fit for your application. Our flexible approach leaves the choice to you, and helps ensure you are getting the best performance and value required for your system.

Pixus offers OpenVPX modules in standard forced-air cooled formats or conduction cooled.

Processors/SBC

Intel or Freescale standard. Processors speeds to 2.6 GHz. 1, 2 or 4 cores. DDR3 DDR4 or other memory options.

FPGAs

Xilinx and Altera standard. Speeds to 2.6 GSPS and above. Various channel options. DDR3, DDR4 or other memory options.

I/O & Specialty

Various I/O and specialty OpenVPX boards are available. Consult Pixus for options.

Carriers & Mezzanines

Carriers and mezzanines such as FMC, XMC, PMC. Mezzanine types include A/D & D/A, networking & I/O, and RF.

Switches

Ethernet switches from 1G, 10G, or 40G. Layer 2 or Layer 3. Various port options. Standard management and redundancy features.

Graphics/GPGPU

NVIDIA and ATI options, consult Pixus for other options. High GFlop CUDA processing engine options. HD/SDI/HDMI display options. Rugged conduction cooled options available.

Storage

Single or multiple SSD (solid state disk) options or no disk (integrated) versions. Various storage capacity for SATA or SAS drives. RAID and Advanced RAID options.

Do our quick "30-second" registration to view the full VPX board configuration sheet.

<http://pixustechnologies.com/products/category/openvpx>

Or contact Pixus to discuss your application.

Pixus Technologies



About AdvancedTCA



100G
AdvancedTCA®

AdvancedTCA is a high-performance architecture used in many MIL/Aero, Communications, and Physics/Research applications. The larger board size (8U x 280mm), high-speed backplanes (up to 100GbE), and cooling focus make the architecture a favorite for very high bandwidth requirements.

AdvancedTCA's features include

- System availability of at least 99.999%
- Hot-swap capability ensures uninterrupted operation
- Transmission rates of up to 2.5 Tbit/s
- Large board formats: 8U x 280 mm
- Switched fabric architecture: Full Mesh and Dual Star
- Cooling solutions up to 400W per board
- Support of different protocols (Ethernet, Infiniband, Rapid I/O, PCI-Express)
- Defined performance up to 40GbE-KR, 100G ATCA versions currently in design

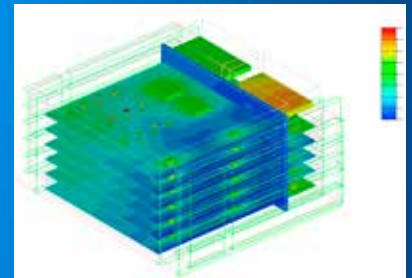

Pixus' pre-cursor Kaparel introduced the "most successful AdvancedTCA shelf solution" and continues to innovate today. The company provides configuration selection and integration services. Our xTCA product line comprises of complete standard shelf solutions for AdvancedTCA including shelf management, backplane and cooling concepts, fully wired and function-tested. The range is complemented by filler panels and face plates, as well as AMC/ATCA carriers in two variants.

Board Options

- Processors -- Intel based, latest chipsets available.
- A/D & D/A Converters -- Xilinx based, newest generation available. High GSPS and data slices.
- Graphics & GPGPU -- GPGPU and high-performance graphics boards for video capture, processing, and display.
- Switches -- Various ports options, 10G or 40G speeds. Layer 2 or Layer 3.
- Specialty Boards -- A wide range of specialty boards are available, contact us with your requirement.





Vertical-Mount AdvancedTCA Shelves

Height	Total Slots	Payload Slots	Cooling/Slot (approx)	Cooling Configuration	Backplane Speed	Compliance	Part Number Prefix
13U	14	12	275W+/slot	Front-to-rear	10G	NEBS, PICMG 3.0	PXS1310
13U	14	12	275W+/slot	Front-to-rear	40G	NEBS, PICMG 3.0	PXS1340
13U	14	12	275W+/slot	Front-to-rear	100G*	NEBS, PICMG 3.0	PXS1311
15U	14	12	400W+/slot	Front-to-rear	10G	NEBS, PICMG 3.0	PXS1510
15U	14	12	400W+/slot	Front-to-rear	40G	NEBS, PICMG 3.0	PXS1540
15U	14	12	400W+/slot	Front-to-rear	100G*	NEBS, PICMG 3.0	PXS1511



Horizontal Mount AdvancedTCA Shelves

Height	Total Slots	Payload Slots	Cooling/Slot (approx)	Cooling Configuration	Backplane Speed	Compliance	Note	Part Number Prefix
6U	6	6	375W+/slot	Side-to-side	10G	PICMG 3.0	Combined switches & shelf managers	PXS0610
6U	6	6	375W+/slot	Side-to-side	40G	PICMG 3.0	Combined switches & shelf managers	PXS0640
8U	6	6	400W+/slot	Front-to-rear	10G	PICMG 3.0	Combined switches & shelf managers	PXS0800
8U	6	6	400W+/slot	Front-to-rear	40G	PICMG 3.0	Combined switches & shelf managers	PXS0840



Hybrid ATCA with AMC Carrier

Height	ATCA Slots	AMC Slots	Cooling/Slot (approx)	Cooling Configuration	Backplane Speed	Note	Part Number Prefix
3U	1	8	400W+/slot	Side-to-side	10G, 40G, or PCIe Gen3	Hybrid ATCA with 8 AMC mid size slots	PXS0309

AdvancedTCA Overview



Pixus offers various AdvancedTCA switches, FPGAs, processors, graphics, RTMs, and specialty cards. With our key partnership, Pixus can help you find the right boards at the right price. For simplicity, you can order your full OpenVPX system and boards through Pixus or we will refer you to the best fit for your application. Our flexible approach leaves the choice to you, and helps ensure you are getting the best performance and value required for your system.

Switches

Multiple port options and low-cost versions. Layer 2 or Layer 3 managed. 10G or 40G switch options. Versions with AMC slots. Optional integrated shelf management.

FPGAs

Xilinx standard with Altera versions optional. Xilinx versions in Kintex-7, Virtex-7, and other Series-7 or UltraScale optional. Versions for A/D with multiple channel options. Up to 2.6 GSPS.

Processors

Intel standard, other chipsets optional. Latest Xeon and Core i processors. Various core options and 10G or 40G Ethernet channels. Versions with PCIe Gen 3 carriers, other specialty features.

Graphics

Various specialty graphics modules and interfaces. Carrier for standard commercial PCIe Gen 3 cards. Video mixing options.

Specialty Cards

The specialty cards include RTMs, I/O modules and other features. Contact Pixus for more information.

Do our quick “30-second” registration to view the full AdvancedTCA board configuration sheet.

<http://pixustechnologies.com/products/category/advancedtca>

Or contact Pixus to discuss your application.

Pixus Technologies



Shelf/Chassis Managers

Type	Base Controller Design	Management Type	Description	Dimensions	Plugging	Part No.
ATCA Switching Shelf Manager	VadaTech	IPMI	Combined 10G ATCA switch and shelf manager, full shelf management (fan, power, etc)	1.0" H x 5.685" W x 11.096" D	6U ATCA SlotSaver Chassis, custom other	PSM_VTAP10
ATCA Switching Shelf Manager	VadaTech	IPMI	Combined 40G ATCA switch and shelf manager, full shelf management (fan, power, etc)	1.0" H x 5.685" W x 11.096" D	6U ATCA SlotSaver Chassis, custom other	PSM_VTAP40
ShMM Shelf Manager	VadaTech	IPMI	Fan controller, Power entry module, LED, and other ports	Credit-card size baseboard, modifiable carrier interfaces	3U VPX, custom other	PSM_VTFC03
ShMM Shelf Manager	PigeonPoint ShMM-700	IPMI	Fan controller, Power entry module, LED, and other ports	Credit-card size baseboard, modifiable carrier interfaces	3U VPX, custom other	PSM_PPFC70
Fan controller/ alarm card	Control Resources	I2C	Fan controller and alarm card, programmable speed control	.863" H x 1.5" W x 9" D	Fixed module placed in chassis	PSM_CRFF06

ATCA



ATCA face plate kit

- With integral cover for component side and for board attachment
- Including foam EMC seal (stick-on)
- Including hot swap injector/extractor handles
- Customer-specific machining available on request

Material:
Stainless steel

Supply includes:
1 face plate, 2 handles, EMC seal, mounting screws.

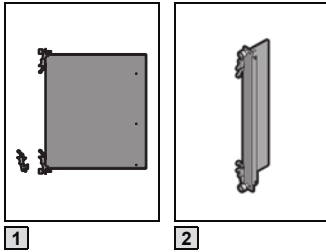

EMC

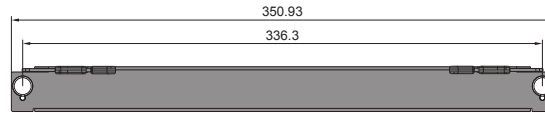

Face plate

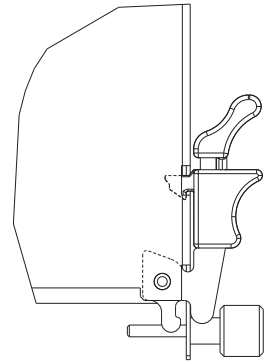
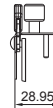

Handle/microswitch

Description	U	HP	Packs of	Model No. RP
1 Face plate, front	8	6	1	9906.693
2 Face plate, rear	8	6	1	9910.379

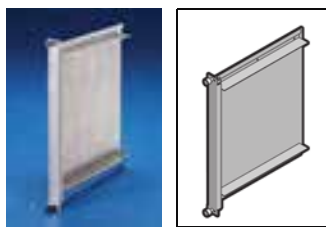

ATCA filler panel kit

- To conceal unused slots
- Optionally with or without air routing
- Including foam EMC seal (stick-on)

Material:
Stainless steel

Supply includes:
1 face plate, EMC seal, mounting screws.

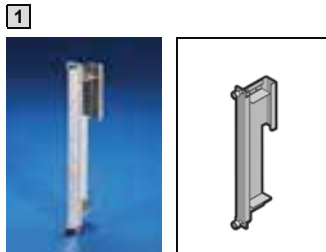

Description	U	HP	Packs of	Model No. RP
1 Face plate, front, with air routing	8	6	1	9906.694
2 Face plate, rear, with air routing	8	6	1	9910.185
3 Face plate, front/rear, without air routing	8	6	1	9910.380



EMC



Cable Management Trays

- For cable clamping and routing
- Attachment to the side panels
- Front cable tray with vent holes for optimum air infeed
- Folds down forwards to ensure easy access to the boards



Assembly	Packs of	Model No. RP
1 front	1	02A000183
2 rear	1	02A000184

About MicroTCA



MicroTCA is a smaller form factor architecture that is related to AdvancedTCA. The Advanced Mezzanine Cards (AMCs) that are used in many AdvancedTCA applications as a daughter card are the core modules for MicroTCA. The AMCs are 75 x 180mm boards (or 150mm tall in the double module size). It offers the ability to have very high performance in a small space with speeds up to 40GbE, PCIe Gen3, etc. MicroTCA allows up to 12 AMCs in a system standard with a MicroTCA Carrier Hub (MCH) with IPMB platform management.

Pixus Technologies specializes in customized enclosure systems and integration of a vast selection of AMCs in the marketplace. The chassis size range from 1U, 2U, 5U, 8U (MicroTCA.4 with rear I/O), and custom sizes. Up to 12 AMCs can be housed in a 1U chassis (a deep chassis with front and rear-loading AMCs) for tremendous performance density.

Pixus has also developed unique device-mounting chassis to hold specialty analyzers or RF devices in the rear of the embedded computing system.



MicroTCA Systems

Standard and customized MicroTCA® shelves and system solutions. With expertise in xTCA systems, along with backplane and cooling specialists, Pixus will help you create a winning μ TCA solution.



MicroTCA Modules

Pixus Technologies can help you configure your MicroTCA system based on your requirements. We help you select the best modules in the industry for your application that meet your budget and performance goals.



1U-2U Horizontal-mount MicroTCA enclosures

Height	AMC Slots	Cooling Configuration	MCHs	Power Type	Type	Part Number Prefix
1U	6 mid-size modules	Side-to-side	1 - integrated	AC or DC, single or redundant	Front load	PXS0112
1U	6 mid-size modules	Front-to-rear	1 - integrated	AC or DC, single or redundant	Front load	PXS0112
1U	6 mid-size modules	Side-to-side	1 or 2, open (NAT, VadaTech, other)	AC or DC, single or redundant	Front load. Versatile modular design.	PXS0108
1U	10 mid-size modules	Side-to-side	1 - integrated	AC or DC, single or redundant	Deep chassis, front & rear load. Special routing.	PXS0112
1U	12 mid-size modules	Side-to-side	1 - integrated	AC or DC, dual PSU	Deep chassis, front & rear load.	PXS0112
1U	2 double modules	Side-to-side	1 - integrated	AC or DC, single or redundant	MTCA.4 for Physics	PXS0112
2U	12 mid-size modules	Side-to-side	2, open (NAT, VadaTech, other)	AC or DC, single or redundant	Front load	PXS0212
2U	6 mid-size modules	Side-to-side	1, open (NAT, VadaTech, other)	AC or DC, single or redundant	MTCA.4 for Physics	PXS0212



5U-8U Horizontal-mount MicroTCA enclosures

Height	AMC Slots	Cooling Configuration	MCHs	Power Type	Type	Part Number Prefix
5U	10-12 modules, various size options	Front-to-rear	1 or 2, open (NAT, VadaTech, other)	AC or DC, single or redundant	Front load, mix of module options	MTCA500
7U	11-12 mid-size double modules	Front-to-rear	1 or 2, open (NAT, VadaTech, other)	AC or DC, dual	Front load, mix of module options	MTCA700
8U	12 mid-size double modules	Front-to-rear	1 or 2, open (NAT, VadaTech, other)	AC or DC, dual or quad	Front load, mix of module options	MTCA800



Rugged MicroTCA Enclosures

Size	AMC Slots	Cooling Configuration	MCHs	Power Type	Type	Part Number Prefix
1U rackmount	6	Front-to-rear	1 - integrated VadaTech	AC or DC, single or redundant	Meets MIL 810/901D for shock/vibration	PXS01R6
1/2 ATR	6	Conduction	1, open (NAT, VadaTech, other)	AC or DC, single	Meets MIL 810/901D for shock/vibration	ATR012

MicroTCA Modules

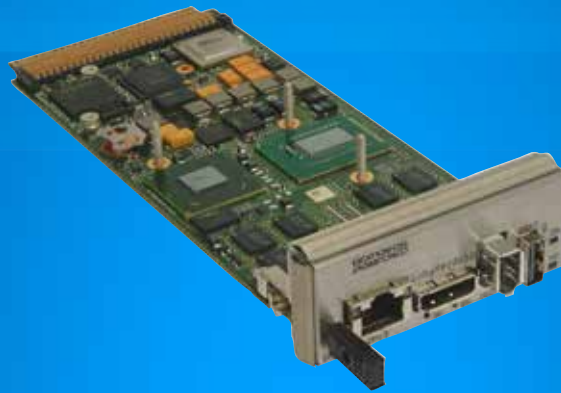

Pixus Technologies can help you configure your MicroTCA system based on your requirements. We help you select the best modules in the industry for your application that meet your budget and performance goals. For simplicity, you can order your full MicroTCA system and boards through Pixus or we will refer you to the best fit for your application. Our flexible approach leaves the choice to you, and helps ensure you are getting the best performance and value required for your system.

Processors/SBC

Intel or Freescale standard. Processors speeds to 2.6 GHz. 1, 2 or 4 Cores. DDR3, DDR4 or other memory options.

Switches

Ethernet switches from 1G, 10G, or 40G. Layer 2 or Layer 3. Various port options. Standard management and redundancy features.

FPGAs

Xilinx and Altera standard. Speeds to 2.6 GSPS and above. Various channel options. DDR3, DDR4 or other memory options.

Graphics/GPGPU

NVIDIA and ATI options, consult Pixus for other options. High GFlop CUDA processing engine options. HD/SDI/HDMI display options. Rugged conduction cooled options available.

I/O & Specialty

Various I/O and specialty OpenVPX boards are available. Consult Pixus for options.

Storage

Single or multiple SSD (solid state disk) options or no disk (integrated) versions. Various storage capacity for SATA or SAS drives. RAID and Advanced RAID options.

Carriers & Mezzanines

Carriers and mezzanines such as FMC, XMC, PMC. Mezzanine types include A/D & D/A, networking & I/O, and RF.

Other 19" Rackmount Architectures Overview



Other 3U, 6U, and Specialty Eurocard

Eurocard-based systems provide an open-standard COTS approach for your system solution. This provides standardization with the benefits of an open-standard architecture, which include:

- Multi-vendor options, more choices
- Less risk, not relying on one vendor
- Selection options of “best in class” for all modules
- Proven design in commercial, industrial, and MIL/Aero
- Less obsolescence risk with multiple vendors
- Lower prototyping/development costs and time-to-market

Typical plug-in modules are 3U or 6U with a 160mm depth. OpenVPX, CompactPCI, VME, and VME64x are open standard backplane architectures commonly used in Eurocard systems. (For OpenVPX products, see the Pixus OpenVPX section.) Enclosures are available in front-to-rear, bottom-to-top, and side-to-side cooling configurations. The chassis can come with or without integrated fan trays or with redundant push-pull cooling. EMC versions are also standard.

There are several legacy architectures that utilize Eurocard-based systems. This includes:

- VME/VME64x
- CompactPCI (legacy) and new CompactPCI Serial
- PXI
- VXS
- Other

Boards

Pixus is able to help configure your Eurocard-based system. This includes switches, SBCs/processors, A/D & D/A Converters, FPGAs, graphics, storage, I/O cards, and specialty boards. Contact Pixus to discuss your application.

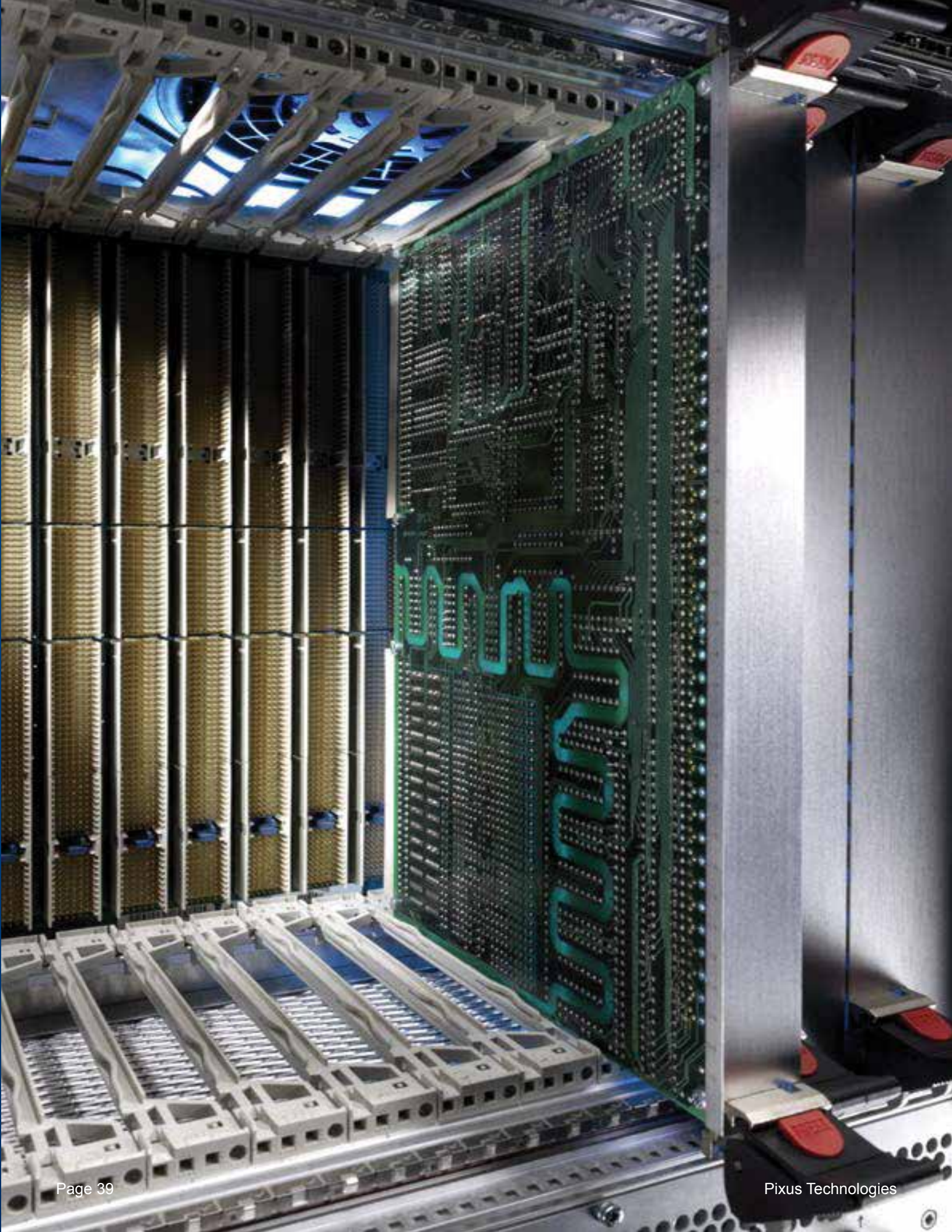

Outstanding Results



Laboratory Equipment

	Electronic packaging	Page
12	2 subracks Ripac Vario 3 U, 160 mm deep	p. 97
13	Horizontal installation kit	p. 121
14	Trim frame, vented, for horizontal installation kit	p. 122
15	2 subracks Ripac Vario 6 U, 160 mm deep	p. 97
16	Vertical assembly kits	p. 121
17	Front panels, handles	p. 134
18	Guide rails	p. 122
19	Box type plug-in units	p. 152
20	Front panels	p. 146
21	Rack-mounted fan between the subracks	p. 88
22	– Fan	p. 80
23	– Power pack	p. 70
24	– Drive chassis	p. 150



Subrack Ripac Vario 3U



EMC measures

Conductive surface finish of all system components. EMC gaskets of stainless steel make contact with the individual components. EMC front panels with EMC gaskets ensure reliable contact.



ESD protection

ESD pin and ESD contact in the guide rail to discharge static charges before making contact with the board type plug-in unit. ESD contact in the PCB guide ensures permanent direct discharge via the PCB.

Climate control

Maximum air flow, due to the narrow design of the guide rails and horizontal rails. Individual air flow management ensures targeted air routing and optimum heat dissipation. Optionally from bottom to top or from front to rear. High-performance RiCool fan ensures optimum ventilation. 1U, hot swap-compatible 204 m³/h, including speed control and fault alarm signal.



Systems for CompactPCI

Systems for VME/VME64x

Overview of benefits

- Systems for the configuration of industrial computers to CompactPCI, OpenVPX, cPCI Serial, or VMEbus specifications
- Robust mechanical system
- Individual configurations available on request
- Fully assembled, pre-wired and tested, including backplane and power supply unit
- Individual airflow management
- Complies with IEC 60 297-3 and IEEE 1101.1/10/11 as well as CompactPCI spec. 2.0 Rev. 3.0 (PICMG)

Slim-Box Vario 1U, 2U

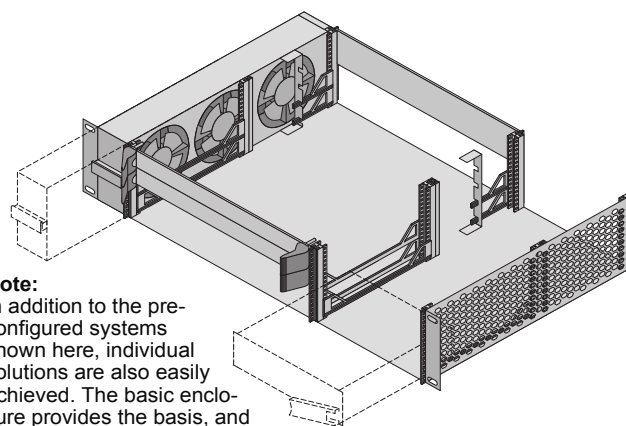

Note:
In addition to the pre-configured systems shown here, individual solutions are also easily achieved. The basic enclosure provides the basis, and is variably populated with the required components.

Technical specifications:

- Rack-mount enclosure 482.6 mm (19") for the horizontal installation of boards
- Front and rear 2 slots per U for cPCI boards
- Enclosure cooling from left to right

- EMC and ESD compatible design
- Includes fan tray
- Complies with IEC 60 297-3-101, -102, -103

Material:

Sheet steel, spray-finished (black)

Slim-Box Vario cPCI		1U			2U		
For PCBs		6U x 160	6U x 160		6U x 160	3U x 160	
		With rear I/O	With rear I/O		With rear I/O	Without rear I/O	
Model No. RP complete system		9909.580	9909.582		9909.586	9909.588	
Item	Package description			Model No. RP			Model No. RP
1	Basic enclosure, EMC, fully assembled, 300 mm deep	1	1	9912.459	1	1	9912.048
2	ATX PSU control module, 3U x 4 HP, EMC (kit)	-	1	9913.998	-	-	9913.998
3	Rear panel for AC/DC ATX PSU (200 W), rear, 1U	-	1	9909.961	-	-	9912.050
4	AC Power Entry Module, 3U x 8 HP, IEC (kit)	1	-	9910.972	1	1	9912.288
5	Slim drive support (kit)	-	-	-	1	1	9912.289
6	Rails for standard 3U components (kit)	1	1	9912.464	-	-	9912.056
7	Front sub-division rails in 2 x 3U (kit)	-	-	9912.920	-	1	9912.053
8	Guide supports, rear I/O	1	1	9912.470	1	-	9912.054
9	Fan tray with air filter and 12 V DC fan, fully wired	1	1	9912.473	1	-	9909.191
10	Fan tray with air filter and 12 V DC alarm fan, fully wired	-	-	-	-	1	9909.194
Monitoring							
11	EMC front panel, 3U x 4 HP with MPS controller module	-	-	-	-	1	9909.193
12	MPS display module, EMC, 3U x 4 HP	-	-	-	-	1	9912.294
13	EMC front panel, 3U x 4 HP with MPS fan module	-	-	-	-	1	9912.293
Power supplies/backplanes for plug-in power supplies							
14	ATX PSU, AC/DC, wide range, 1U, 200 W	-	1	9907.585	-	-	-
15	Prepared for plug-in PSU, AC/DC, wide range, 3U, 200 W	(1)	-	3688.694	(1)	(1)	3688.694
16	PSU backplane 3U, single	1	-	9905.105	1	-	9905.105
17	PSU backplane 3U, dual	-	-	-	-	1	3688.603
Guide rails/filler panels							
18	Keyable guide rail, 160 mm, grey	2	2	3684.669	6	6	3684.669
19	Keyable guide rail, 160 mm, red, for system slots	2	2	3686.063	2	2	3686.063
20	Keyable guide rail, 160 mm, green, with offset, for PSU	2	-	3687.832	2	4	3687.832
21	Guide rail for rear I/O, 80 mm, grey, top	2	2	3687.936	4	-	3687.936
22	Guide rail for rear I/O, 80 mm, grey, bottom	2	2	3687.937	4	-	3687.937
23	Grounding bush + contact spring for rear I/O	4	4	3689.036	8	-	3689.036
24	ESD board contact spring	4	4	3684.978	8	8	3684.978
25	ESD contact spring for front panel	2	2	3684.979	4	4	3684.979
26	Guide rail, 4.4" for drive holder	-	-	-	2	2	3686.990
27	Filler panel, EMC, 3U x 8 HP (kit)	-	-	-	1	1	3685.182
28	Filler panel, EMC, 6U x 16 HP (kit)	-	-	-	-	1	3685.349
Backplanes							
29	Backplane cPCI, 3U, 4 slots, system slot on right, 64 bit	-	-	-	-	1	3689.309
30	Backplane cPCI, 6U, 2 slots, system slot on right, 64 bit	1	1	3689.321	-	-	-
31	Backplane cPCI, 6U, 4 slots, system slot on right, 64 bit	-	-	-	1	-	3689.323
32	Backplane 9U, Monolithic, 2 slots	(1)	-	3689.329	(1)	(1)	3689.329
33	Backplane 9U, Monolithic, 3 slots	-	-	-	(1)	(1)	3689.330
34	Backplane 9U, Monolithic, 4 slots	-	-	-	(1)	(1)	3689.331

(1) Quantity not included with the supply!

Slim-Box Vario 3U, 4U

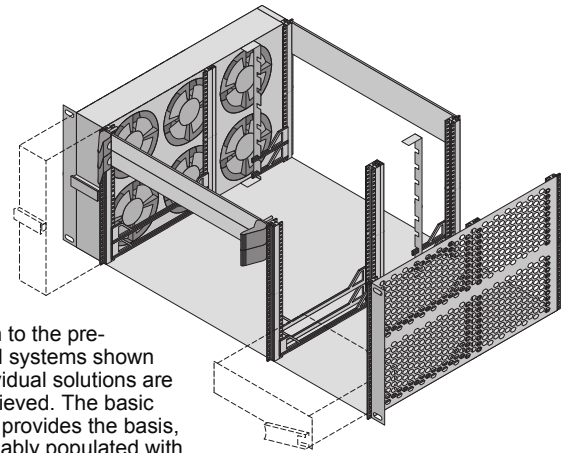

Note:
In addition to the pre-configured systems shown here, individual solutions are easily achieved. The basic enclosure provides the basis, and is variably populated with the required components.

Technical specifications:

- Rack-mount enclosure 482.6 mm (19") for the horizontal installation of boards
- Front and rear 2 slots per U for cPCI boards
- Enclosure cooling from left to right

- EMC and ESD compatible design
- Includes fan tray
- Complies with IEC 60 297-3-101, -102, -103

Material:

Sheet steel, spray-finished (black)

Slim-Box Vario cPCI		3U			4U		
For PCBs		6U x 160	6U x 160		6U x 160	6U x 160	
		With rear I/O	With rear I/O		With rear I/O	With rear I/O	
Model No. RP complete system		9912.355	9912.356		9912.357	9912.358	
Item	Package description			Model No. RP			Model No. RP
1	Basic enclosure, EMC, fully assembled, 300 mm deep	1	1	9912.460	1	1	9912.461
2	ATX PSU control module, 3U x 4 HP, EMC (kit)	-	1	9913.998	-	-	9913.998
3	Rear panel for AC/DC ATX PSU (300 W), rear, 3U x 8 HP (kit)	-	1	9912.921	-	-	9912.921
4	AC Power Entry Module, 3U x 8 HP, IEC (kit)	1	-	9912.288	1	1	9912.288
5	Slim drive support (kit)	1	1	9912.462	1	1	9912.463
6	Guide supports, rear I/O	1	1	9912.471	1	1	9912.472
7	Fan tray with air filter and 12 V DC fan	1	1	9912.474	-	-	9912.475
8	Fan tray with air filter and 12 V DC alarm fan	-	-	-	1	1	9912.478
Monitoring							
9	EMC front panel, 3U x 4 HP with MPS controller module	-	-	-	1	-	9909.193
10	MPS display module, EMC, 3U x 4 HP	-	-	-	1	-	9912.294
11	MPS controller module and LCD display module, EMC, 6U x 8 HP	-	-	-	-	1	9912.483
12	EMC front panel, 3U x 4 HP with MPS fan module	-	-	-	1	1	9912.293
13	EMC front panel, 3U x 4 HP with MPS temperature module	-	-	-	1	1	9909.230
14	Red temperature sensor, L = 600 mm	-	-	-	2	2	3397.538
Power supplies/backplanes for plug-in power supplies							
15	ATX PSU, AC/DC, wide range, 1U, 300 W	-	1	9907.584	-	-	-
16	Plug-in PSU, AC/DC, wide range, 3U, 250 W	(1)	-	3688.695	(2)	(1)	3688.695
17	PSU backplane 3U, single	1	-	9905.105	-	1	9905.105
18	PSU backplane 3U, dual	-	-	-	1	-	3688.603
19	PSU backplane 3U, triple	(1)	-	9904.131	(1)	(1)	9904.131
Guide rails/filler panels/backplanes							
20	Keyable guide rail, 160 mm, grey	10	10	3684.669	14	10	3684.669
21	Keyable guide rail, 160 mm, red, for system slots	2	2	3686.063	2	2	3686.063
22	Keyable guide rail, 160 mm, green, with offset, for PSU	2	-	3687.832	4	2	3687.832
23	Guide rail for rear I/O, 80 mm, grey, top	6	6	3687.936	8	6	3687.936
24	Guide rail for rear I/O, 80 mm, grey, bottom	6	6	3687.937	8	6	3687.937
25	Grounding bush + contact spring for rear I/O	12	12	3689.036	16	12	3689.036
26	ESD board contact spring	24	24	3684.978	32	24	3684.978
27	ESD contact spring for front panel	12	12	3684.979	16	12	3684.979
28	Guide rail, 4.4" for drive holder	2	2	3686.990	2	2	3686.990
29	Filler panel, EMC, 3U x 8 HP (kit)	1	-	3685.182	-	-	-
30	Filler panel, EMC, 3U x 12 HP (kit)	-	1	3685.184	-	-	-
31	Filler panel, EMC, 3U x 16 HP (kit)	1	1	3685.348	1	1	3685.348
32	Filler panel, EMC, 6U x 8 HP (kit)	-	-	-	-	1	3685.190
33	Backplane cPCI, 6U, 6 slots, system slot on right, 64 bit	1	1	3689.325	-	1	3689.325
34	Backplane cPCI, 6U, 8 slots, system slot on right, 64 bit	-	-	-	1	-	3689.327
35	Backplane 9U, Monolithic, 2 slots	(1)	-	3689.329	(1)	(1)	3689.329
36	Backplane 9U, Monolithic, 3 slots	(1)	-	3689.330	(1)	(1)	3689.330
37	Backplane 9U, Monolithic, 4 slots	(1)	-	3689.331	(1)	(1)	3689.331

(1) (2) Quantity not included with the supply!

Ripac 3U, 5 slots/4U, 7 slots Horizontal

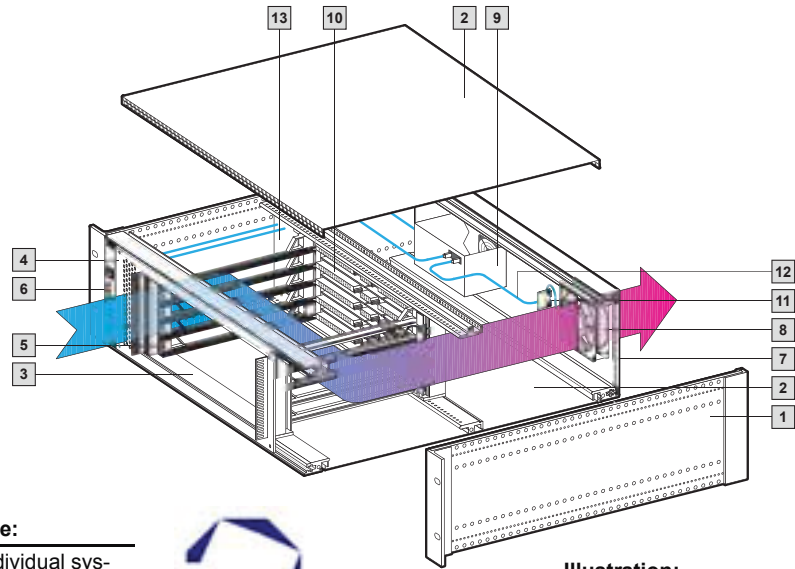

Technical specifications:
 Subrack, 405 mm deep, for installation in 482.6 mm (19") enclosures or cases. Prepared to accommodate cPCI boards and drives. Includes MPS Monitoring. Complies with IEC 60 297-3-101, -102, -103. Fully assembled, pre-wired and tested.

 **Pixus service:**
 Modifications or individual system solutions can be provided at short notice. Pixus' system specialists will be happy to assist you with planning and configuration.



Illustration:
 MPS system 3U for cPCI

U	3	4	Page
Side panel depth mm	405	405	
Wiring space (depth in mm)	210	210	
For PCB	6U x 160 mm	6U x 160 mm	
MPS system Model No. RP for cPCI	9910.944	9910.945	

Mechanical supply includes

Description	Material	Qty.		
1 Ripac basic subrack system (side panels, horizontal rails, flanges, EMC gaskets)	Aluminium, clear-chromated/stainless steel	1	1	-
2 Top and bottom covers, solid	Aluminium	2	2	134
13 Air partition	Aluminium	1	1	83
EMC shielding plate for fan	Aluminium, clear-chromated	1	1	86
3 Horizontal mounting kit	Aluminium, clear-chromated	1	1	126
4 Trim frame for horizontal mounting kit	2.5 mm aluminium, clear-chromated	1	1	127
5 Plastic guide rails, keyable	Polycarbonate UL 94-V0	8	12	128
Plastic guide rails, keyable, red	Polycarbonate	2	2	128
6 EMC front panel 3 U/5 HP for MPS monitoring	2.5 mm aluminium, clear-chromated	1	-	-
EMC front panel 4 U/5 HP for MPS monitoring	2.5 mm aluminium, clear-chromated	-	1	-
7 EMC rear panel 3 U/84 HP with fan and connector cut-out	2.5 mm aluminium, clear-chromated	1	-	-
EMC rear panel 4 U/84 HP with fan and connector cut-out	2.5 mm aluminium, clear-chromated	-	1	-

Electrical/electronic supply includes

Description	Technical specifications	Qty.		
8 DC fan	12 V DC, 48 m ³ /h, per fan (UL, CSA, VDE) optionally speed-controlled	1	1	85
9 Power supply unit ATX, PS/2 (RP 3687.793)	300 W	1	1	-
10 cPCI backplane	6.5U, 5 slots	1	-	51
LED display module for MPS monitoring	for 3.3 V, +5 V, ±12 V, fan failure and temperature alarm	1	1	-
11 Fan module	-	1	1	-
12 DC cable harness	-	■	■	-
AC cable harness	-	■	■	-

■ Included with the supply.

Rackmount systems, Ripac 4U/7U, 8 slots



Technical specifications:
 Subrack, 405 mm deep, for installation in 482.6 mm (19") enclosures or cases. Prepared to accommodate cPCI boards and drives. Includes MPS Monitoring.
 Complies with IEC 60 297-3-101, -102, -103.
 Fully assembled, pre-wired and tested.



Pixus service:

Modifications or individual system solutions can be provided at short notice. Pixus' system specialists will be happy to assist you with planning and configuration.

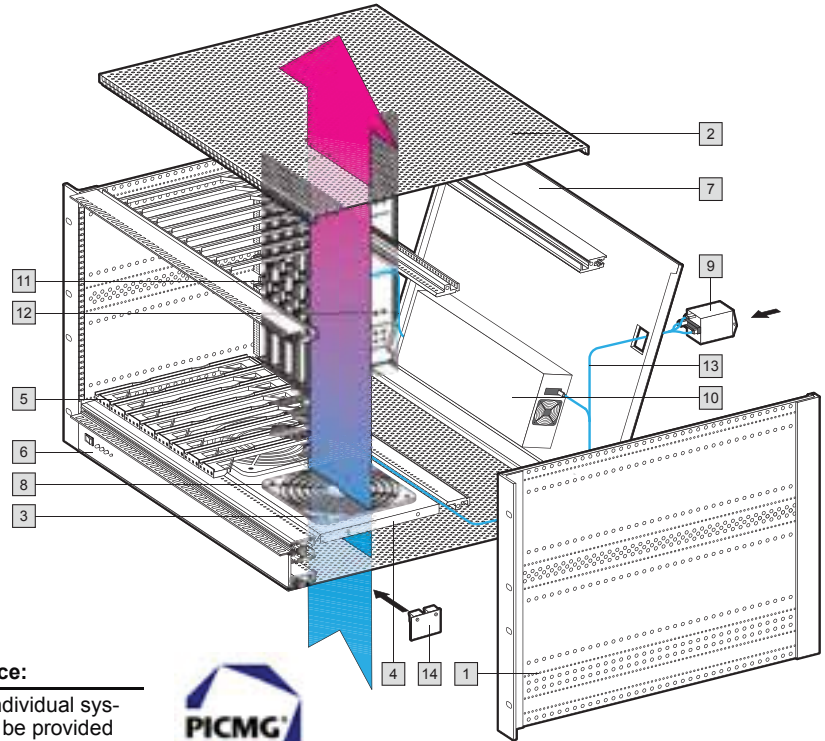

Illustration:
 MPS system 7U for cPCI

U	4 (3 + 1)	7 (6 + 1)	Page
Side panel depth mm	405	405	
Wiring space (depth in mm)	210	210	
For PCB	3U x 160 mm	6U x 160 mm	
MPS system Model No. RP for cPCI	9910.946	9910.948	

Mechanical supply includes

Description	Material	Qty.		
1 Ripac basic subrack system (side panels, horizontal rails, flanges, EMC gaskets)	Aluminium, clear-chromated/stainless steel	1	1	–
2 Top and bottom covers, vented	Aluminium	2	2	134
3 Finger guard	Polyamide	3	3	86
4 Fan mounting plate	1 mm aluminium, anodised	1	1	82
5 Plastic guide rails, keyable	Polycarbonate UL 94-V0	14	14	127
Plastic guide rails, keyable, red	Polycarbonate	2	2	128
6 EMC front panel 1 U/84 HP for MPS monitoring	2.5 mm aluminium, clear-chromated	1	1	–
EMC rear panel 4 U/84 HP, horizontally hinged with connector cut-out	2.5 mm aluminium, clear-chromated	1	–	–
7 EMC rear panel 7 U/84 HP, horizontally hinged with connector cut-out	2.5 mm aluminium, clear-chromated	–	1	–

Electrical/electronic supply includes

Description	Technical specifications			
8 DC fan	24 V DC, 140 m ³ /h, per fan (VDE, UL, CSA) optionally speed-controlled	3	3	85
9 IEC filtered mains inlet	6 A (VDE, UL, CSA)	1	1	–
10 Open frame power supply (RP 3687.695)	400 W, 3.3 V/25 A, 5 V/25 A, 12 V/8 A, –12 V/7 A (VDE, UL, CSA)	–	1	–
Power supply unit ATX PS/2 (RP 3687.793)	300 W with switch connection cable	1	–	51
cPCI backplane	3.5U, 8 slots	1	–	52
11 cPCI backplane	7U, 8 slots	–	1	–
LED display module for MPS monitoring	for 3.3 V, +5 V, ±12 V, fan failure and temperature alarm	1	1	–
12 DC cable harness	–	■	■	–
13 AC cable harness	–	–	■	–
14 Fan module	–	1	1	–

■ Included with the supply.

Rackmount systems, Ripac 7U, 8 slots

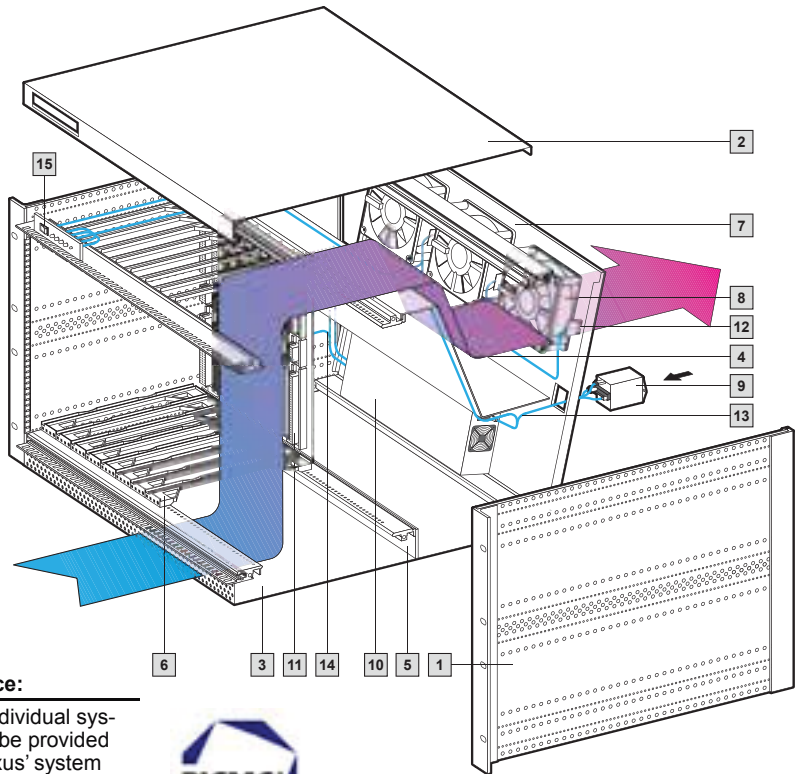

Technical specifications:
 Subrack, 405 mm deep, for installation in 482.6 mm (19") enclosures or cases. Prepared to accommodate cPCI boards and drives. Includes MPS Monitoring.
 Complies with IEC 60 297-3-101, -102, -103.
 Fully assembled, pre-wired and tested.

Pixus service:

Modifications or individual system solutions can be provided at short notice. Pixus' system specialists will be happy to assist you with planning and configuration.



Illustration:
 MPS system 7U for cPCI

U	7 (6 + 2 x 1/2)	Page
Side panel depth mm	405	
Wiring space (depth in mm)	210	
For PCB	6 U x 160 mm	
MPS system Model No. RP for cPCI	9910.947	

Mechanical supply includes

Description	Material	Qty.	
1 Ripac basic subrack system (side panels, horizontal rails, flanges, EMC gaskets)	Aluminium, clear-chromated/stainless steel	1	-
2 Cover with 1/2 U edge fold and cut-outs for LED/switches	Aluminium	1	137
3 Bottom cover with 1/2 U edge fold, ventilated at the front	Aluminium	1	137
EMC shielding plate for fan	Aluminium, clear-chromated	3	86
4 Air baffle	Aluminium	1	83
5 Air block panel 1/2U	Epoxy	1	83
6 Plastic guide rails, keyable	Polycarbonate UL 94-V0	14	128
Plastic guide rails, keyable, red	Polycarbonate	2	128
7 EMC rear panel, horizontally hinged, 7U, with fan and connector cut-out	2.5 mm aluminium, clear-chromated	1	-

Electrical/electronic supply includes

Description	Technical specifications		
8 DC fan	12 V DC, 140 m ³ /h, per fan (UL, CSA, VDE) optionally speed-controlled	3	85
9 IEC filtered mains inlet	6 A (VDE, UL, CSA)	1	-
10 Open frame power supply (RP 3687.695)	400 W, 3.3 V/25 A, 5 V/25 A, 12 V/8 A, -12 V/7 A (VDE, UL, CSA)	1	-
11 cPCI backplane	7U, 8 slots	1	52
12 Fan module	-	1	-
13 AC cable harness	-	■	-
14 DC cable harness	-	■	-
15 LED display module for MPS monitoring	for 3.3 V, +5 V, ±12 V, fan failure	1	-
Temperature module		1	-

■ Included with the supply.

Rackmount systems, Ripac 9U, 8 slots, with RiCool radian fan

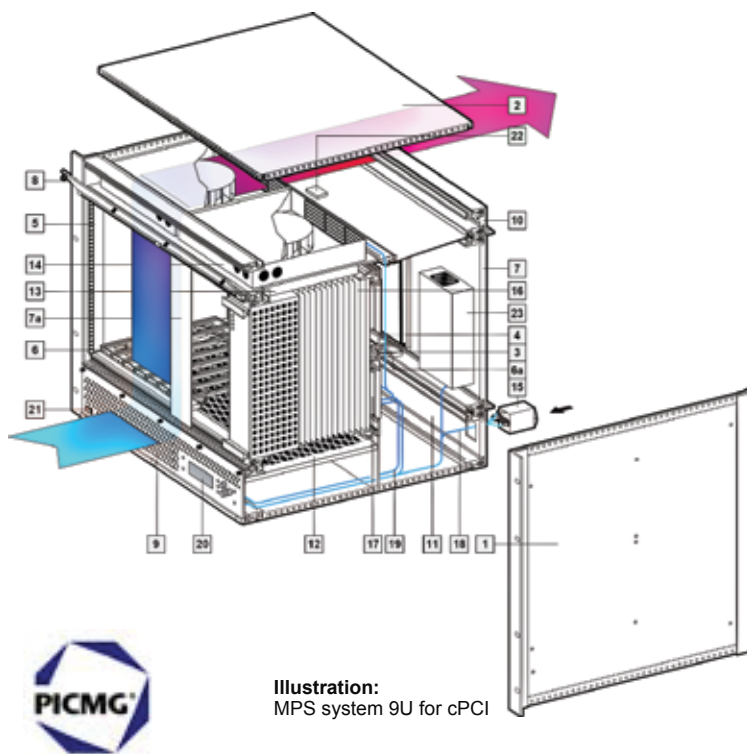

Technical specifications:
 Subrack, 290,5 mm deep, for installation in 482.6 mm (19") enclosures or cases. Prepared to accommodate cPCI boards and drives. Includes MPS Monitoring.
 Complies with IEC 60 297-3-101, -102, -103.
 Fully assembled, pre-wired and tested.

 **Pixus service:**
 Modifications or individual system solutions can be provided at short notice. Pixus' system specialists will be happy to assist you with planning and configuration.

Illustration:
 MPS system 9U for cPCI

U	9 (6 + 2 x 1 1/2)	Page
Side panel depth mm	290,5	
Wiring space (depth in mm)	85,5	
For PCB	6U x 160 mm	
MPS system Model No. RP for cPCI	9909.483	

Mechanical supply includes

Description	Material	Qty.	
1 Ripac basic subrack system (side panels, horizontal rails, flanges, EMC gaskets)	Aluminium, clear-chromated/stainless steel	1	–
2 Top and bottom covers, solid	Aluminium	2	135
3 EMC rear panel 6 U/28 HP + 8 HP	2.5 mm aluminium, clear-chromated	1	–
4 EMC front panel	2.5 mm aluminium, clear-chromated	1	153
5 EMC contact strip	Aluminium, clear-chromated	1	125
6 Plastic guide rails, keyable	Polycarbonate UL 94-V0	14	128
Plastic guide rails, keyable, red	Polycarbonate	2	128
7 Guide rails for I/O transition modules	Polycarbonate UL 94-V0	16	129
Guide rails, keyable, green, for power supply	Polycarbonate	2	129
8 Front panel 1 1/2 U/84 HP, horizontally hinged	2.5 mm aluminium, clear-chromated	1	–
9 Front panel 1 1/2 U/84 HP, vented, horizontally hinged, for MPS monitoring	2.5 mm aluminium, clear-chromated	1	–
10 EMC rear panel 1 1/2 U/84 HP, vented	2.5 mm aluminium, clear-chromated	1	–
11 EMC rear panel 1 1/2 U/84 HP with connector cut-out	2.5 mm aluminium, clear-chromated	–	–
12 Filter mat 84 HP, 160 mm, for slide-in attachment	–	1	–
13 Mounting plate for RiCool	1 mm sheet steel, zinc-plated, passivated	1	–

Electrical/electronic supply includes

Description	Technical specifications		
14 RiCool DC fan, individually removable including fault alarm signal, speed control	24 V DC, 204 m ³ /h, 48 W	2	–
15 IEC filtered mains inlet	6 A (VDE, UL, CSA)	1	–
16 Power supply, plug-in, 6U/8 HP	350 W	1	–
cPCI backplane	7U, 8 slots	1	52
17 cPCI backplane for power supply	–	1	–
18 AC cable harness	–	■	–
19 DC cable harness	–	■	–
20 Display module	for 3.3 V, +5 V, ±12 V, fan failure, data input and output, voltages, temperature	1	–
21 Mains switch	–	1	–
22 Monitoring module for RiCool	–	1	–
23 Power supply for RiCool	–	1	–
Temperature module	–	1	–

Backplanes, Technical Specifications

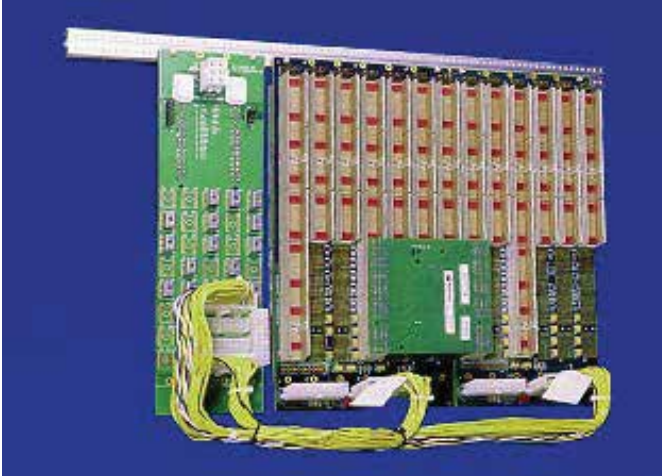

Pixus offers an extensive range of powerful backplanes for cPCI.

- Modular construction facilitates expansion up to a maximum of 21 slots
- Connection between segments via cPCI and/or H.110 bridge modules
- Power input via ATX-compatible connectors or screw terminal
- Additional 2 x 3 Mate-N-Lock connector for 48 V with H.110 backplane
- Optional development of customer-specific monolithic backplanes
- 8 layer
- System slot on right (left upon request)

Modular assembly

The Ripac backplanes in 32 or 64 bit versions allow the configuration of cPCI systems from 2 – 21 slots. This is possible due to the modular design of the backplanes and connection of the individual segments via cPCI or H.110 bridge modules. Each backplane segment contains between 2 and 8 slots and operates in stand-alone mode in conjunction with a CPU board and a power supply unit.

For assembling larger systems, several segments may be joined together via PCI bridge modules fitted at the rear. In such cases, only one of the segments will run in the system slot with a CPU board. The remaining segments will have a subordinate status without CPU boards. However, the first slot on the right of the backplane is available for a standard 32 or 64 bit cPCI host CPU.

Technical specifications

CPU slot

A single 3U or 6U CPU board with 32 or 64 bits is required for each system. The system slot on the right-hand side ensures that 2-slot or wider system boards do not conceal other slots, thus rendering them unusable.

Available slots

Each backplane contains two to eight 3 U or 6 U slots (32 or 64 bit).

Data transfer rate

132/264 MBytes for 32/64 bit version
 +5 V, 33 MHz PCI bus interface
 264/512 MBytes for 32/64 bit version
 +3.3 V, 66 MHz (max. 5 slots) PCI bus interface

PCI bridges

Single backplanes do not require bridges. For each additional backplane, however, a bridge fitted at the rear is required.

Power supply

Voltage supply via one or more ATX connectors.

Control connector

Each backplane has a control connector where +3.3, +5, ±12 V voltages may be picked off, e.g. for the connection of power LEDs.

I/O modules for J3 – J5

I/O modules can be connected at the rear of each slot.

Standards

- PCI 2.1 (PCI specification)
- PICMG 2.0 (cPCI spec.)
- PICMG 2.1 (hot swap spec.)
- IEEE 1101.1, mechanics
- IEEE 1101.10, mechanics
- IEEE 1101.11, mechanics

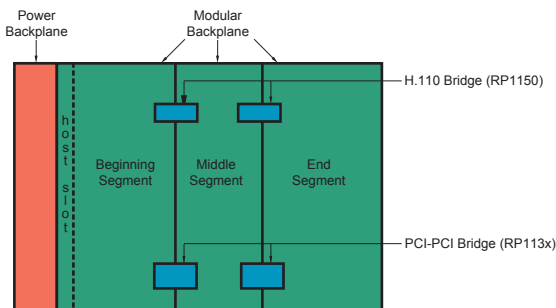

As viewed from rear of subrack

Backplanes, technical specifications

32-bit pin assignment

P2 connector⁹⁾

Pin	Z ⁶⁾	A	B	C	D	E	F
22	GND	GA4 ⁵⁾	GA3 ⁵⁾	GA2 ⁵⁾	GA1 ⁵⁾	GA0 ⁵⁾	GND
21	GND	BP(I/O)	BP(I/O)	BP(I/O)	BP(I/O)	BP(I/O)	GND
20	GND	BP(I/O)	BP(I/O)	BP(I/O)	BP(I/O)	BP(I/O)	GND
19	GND	BP(I/O)	BP(I/O)	BP(I/O)	BP(I/O)	BP(I/O)	GND
18	GND	BP(I/O)	BP(I/O)	BP(I/O)	BP(I/O)	BP(I/O)	GND
17	GND	BP(I/O)	BP(I/O)	BP(I/O)	BP(I/O)	BP(I/O)	GND
16	GND	BP(I/O)	BP(I/O)	BP(I/O)	BP(I/O)	BP(I/O)	GND
15	GND	BP(I/O)	BP(I/O)	BP(I/O)	BP(I/O)	BP(I/O)	GND
14	GND	BP(I/O)	BP(I/O)	BP(I/O)	BP(I/O)	BP(I/O)	GND
13	GND	BP(I/O)	BP(I/O)	BP(I/O)	BP(I/O)	BP(I/O)	GND
12	GND	BP(I/O)	BP(I/O)	BP(I/O)	BP(I/O)	BP(I/O)	GND
11	GND	BP(I/O)	BP(I/O)	BP(I/O)	BP(I/O)	BP(I/O)	GND
10	GND	BP(I/O)	BP(I/O)	BP(I/O)	BP(I/O)	BP(I/O)	GND
9	GND	BP(I/O)	BP(I/O)	BP(I/O)	BP(I/O)	BP(I/O)	GND
8	GND	BP(I/O)	BP(I/O)	BP(I/O)	BP(I/O)	BP(I/O)	GND
7	GND	BP(I/O)	BP(I/O)	BP(I/O)	BP(I/O)	BP(I/O)	GND
6	GND	BP(I/O)	BP(I/O)	BP(I/O)	BP(I/O)	BP(I/O)	GND
5	GND	BP(I/O)	BP(I/O)	BP(I/O)	BP(I/O)	BP(I/O)	GND
4	GND	BP(I/O)	BP(I/O)	BP(I/O)	BP(I/O)	BP(I/O)	GND
3	GND	BP(I/O)	BP(I/O)	BP(I/O)	BP(I/O)	BP(I/O)	GND
2	GND	BP(I/O)	BP(I/O)	BP(I/O)	BP(I/O)	BP(I/O)	GND
1	GND	BP(I/O)	BP(I/O)	BP(I/O)	BP(I/O)	BP(I/O)	GND

32-bit and 64-bit backplane – Technical specifications:

The cPCI specifications define both 32-bit and 64-bit versions. Both versions may be implemented on a 3 U daughterboard. However, the 32-bit version allows the complete P2/J2 connector to be used for user-defined I/O signals (slots 2 – 8). Slot 1 (system slot) uses separate P2/J2 pins for functions such as clock, arbitration, (grant/requests) and other system functions. These pins are printed in bold in the table. In 32-bit systems the P2/J2 connector may optionally be populated at the rear with 16 mm long pins and a transfer frame. Signals can be picked off or I/O boards connected at the rear.

64-bit pin assignment

P2 connector⁹⁾

Pin	Z ⁷⁾	A	B	C	D	E	F
22	GND	GA4 ⁶⁾	GA3 ⁶⁾	GA2 ⁶⁾	GA1 ⁶⁾	GA0 ⁶⁾	GND
21	GND	CLK6	GND	RSV	RSV	RSV	GND
20	GND	CLK5	GND	RSV	GND ⁸⁾	RSV	GND
19	GND	GND	GND ⁸⁾	RSV	RSV	RSV	GND
18	GND	BRSVP2A18	BRSVP2B18	BRSVP2C18	GND	BRSVP2E18	GND
17	GND	BRSVP2A17	GND ⁸⁾	PRST#	REQ6#	GNT6#	GND
16	GND	BRSVP2A16	BRSVP2B16	DEG#	GND ⁸⁾	BRSVP2E16	GND
15	GND	BRSVP2A15	GND	FAL#	REQ5#	GNT5#	GND
14	GND	AD(35)	AD(34)	AD(33)	GND	AD(32)	GND
13	GND	AD(38)	GND	V(I/O) ³⁾	AD(37)	AD(36)	GND
12	GND	AD(42)	AD(41)	AD(40)	GND	AD(39)	GND
11	GND	AD(45)	GND	V(I/O) ³⁾	AD(44)	AD(43)	GND
10	GND	AD(49)	AD(48)	AD(47)	GND	AD(46)	GND
9	GND	AD(52)	GND	V(I/O) ³⁾	AD(51)	AD(50)	GND
8	GND	AD(56)	AD(55)	AD(54)	GND	AD(53)	GND
7	GND	AD(59)	GND	V(I/O) ³⁾	AD(58)	AD(57)	GND
6	GND	AD(63)	AD(62)	AD(61)	GND	AD(60)	GND
5	GND	C/BE(5)#	GND	V(I/O) ³⁾	C/BE(4)#	PAR64	GND
4	GND	V(I/O) ³⁾	BRSVP2B4	C/BE(7)#	–	C/BE(6)#	GND
3 ³⁾	GND	CLK4	GND	GNT3#	–	GNT4#	GND
2 ³⁾	GND	CLK2	CLK3	SYSEN#⁴⁾	–	REQ3#	GND
1 ³⁾	GND	CLK1	GND	REQ1#	–	REQ2#	GND

The signals printed in bold are only assigned in the system slot

¹⁾ "Early mate" pin ²⁾ "Late mate" pin ³⁾ +3.3 V or 5 V ⁴⁾ Earthed with system slot ⁵⁾ GND for 33 MHz backplane, bussed in 66 MHz systems

⁶⁾ Each slot may have its own address code (see cPCI specifications) ⁷⁾ Not for daughtercards ⁸⁾ Not for cPCI cards after version 1.0

⁹⁾ All Pixus standard cPCI backplanes are designed for 64-bit applications on the layout side. With 32-bit versions, the P2/J2 connectors are populated on request.

P1 connector⁹⁾

Pin	Z ⁶⁾	A	B	C	D	E	F
25	GND	5 V	REQ64#	ENUM#	3.3 V	5 V	GND
24	GND	AD(1)	5 V	V(I/O) ³⁾	AD(0)	ACK64#	GND
23	GND	3.3 V	AD(4)	AD(3)	5 V	AD(2)	GND
22	GND	AD(7)	GND	3.3 V	AD(6)	AD(5)	GND
21	GND	3.3 V	AD(9)	AD(8)	M66EN ³⁾	C/BE(0)#	GND
20	GND	AD(12)	GND	V(I/O) ³⁾	AD(11)	AD(10)	GND
19	GND	3.3 V	AD(15)	AD(14)	GND	AD(13)	GND
18	GND	SERR#	GND	3.3 V	PAR	C/BE(1)#	GND
17	GND	3.3 V	SDONE	SBQ#	GND	PERR#	GND
16	GND	DEVSEL	GND	V(I/O) ³⁾	STOP#	LOCK#	GND
15	GND	3.3 V	FRAME#	IRDY	GND ³⁾	TRDY#	GND
12 – 14			KEY AREA				GND
11	GND	AD(18)	AD(17)	AD(16)	GND	C/BE(2)#	GND
10	GND	AD(21)	GND	3.3 V	AD(20)	AD(19)	GND
9	GND	C/BE(3)#	IDSEL	AD(23)	GND	AD(22)	GND
8	GND	AD(26)	GND	V(I/O) ³⁾	AD(25)	AD(24)	GND
7	GND	AD(30)	AD(29)	AD(28)	GND	AD(27)	GND
6	GND	REQ#	GND	3.3 V	CLK	AD(31)	GND
5	GND	BRSVP1A5	BRSVP1B5	RST#	GND	GNT#	GND
4	GND	BRSVP1A4	GND	V(I/O) ³⁾	INTP	INTS	GND
3	GND	INTA#	INTB#	INTC#	5 V	INTD#	GND
2	GND	TCK	5 V	TMS	TDO	TDI	GND
1	GND	5 V	–12 V	TRST#	+12 V	5 V	GND

64-bit CompactPCI pin assignments – Technical specifications:

With the 64-bit CompactPCI, both P1 and P2 connectors are fully assigned with signals. User-defined I/O signal pins are not available. I/O signals are only available with 6 U boards on connectors P3, P4 and P5.

P1 connector⁹⁾

Pin	Z ⁷⁾	A	B	C	D	E	F
25	GND	5 V	REQ64#	ENUM#	3.3 V	5 V	GND
24	GND	AD(1)	5 V	V(I/O) ³⁾	AD(0)	ACK64#	GND
23	GND	3.3 V	AD(4)	AD(3)	5 V	AD(2)	GND
22	GND	AD(7)	GND	3.3 V	AD(6)	AD(5)	GND
21	GND	3.3 V	AD(9)	AD(8)	M66EN ⁴⁾⁵⁾	C/BE(0)	GND
20	GND	AD(12)	GND	V(I/O) ³⁾	AD(11)	AD(10)	GND
19	GND	3.3 V	AD(15)	AD(14)	GND	AD(13)	GND
18	GND	SERR#	GND	3.3 V	PAR	C/BE(1)#	GND
17	GND	3.3 V	SDONE	SBO#	GND	PERR#	GND
16	GND	DEVSEL#	GND	V(I/O) ³⁾	STOP#	LOCK#	GND
15	GND	3.3 V	FRAME#	IRDY#	GND ³⁾	TRDY#	GND
12 – 14			KEY AREA				
11	–	AD(18)	AD(17)	AD(16)	GND	C/BE(2)#	GND
10	GND	AD(21)	GND	3.3 V	AD(20)	AD(19)	GND
9	GND	C/BE(3)#	IDSEL	AD(23)	GND	AD(22)	GND
8	GND	AD(26)	GND	V(I/O)	AD(25)	AD(24)	GND
7	GND	AD(30)	AD(29)	AD(28)	GND	AD(27)	GND
6	GND	REQ#	GND	3.3 V	CLK	AD(31)	GND
5	GND	BRSVA5	BRSVB5	RST#	GND	GNT#	GND
4	GND	BRSVA4	GND	V(I/O)	INTP	INTS	GND
3	GND	INTA#	INTB#	INTC	5 V	INTD#	GND
2	GND	TCK	5 V	TMS	TDO	TDI	GND
1	GND	5 V	–12 V	TRST#	+12 V	5 V	GND

Backplanes



Front view 3.5U

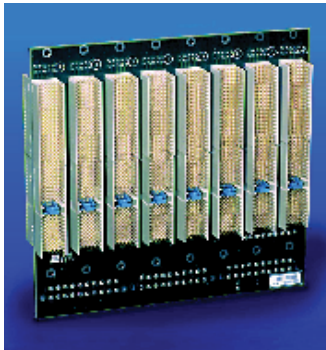

Rear view 3.5U

Backplanes 3U, 3.5U

Number of layers	8, 10 (with 3U)
Layer structure	2 GND layers
PCB thickness	3.2 mm
Data transfer rate	132/264 Mbytes/ 32, 64-bit version
Power inlets	3.5U: 2 – 4 slots: 1 x ATX connector 5 – 7 slots: 2 x ATX connector 8 slots: 3 x ATX connector 3 U: via screws and busbars
Control connector	+3.3 V, +5 V, +12 V, -12 V
VI/O (3 U)	May be set to +5 V or +3.3 V
CPU slot	on right, left upon request
Standards	PCI 2.1 (PCI specification) PICMG 2.0 (CompactPCI) PICMG 2.1 (hot swap) IEEE 1101.1/10/11
Installation height	3.5U (150.9 mm), 3U
Distance between slots	4 HP
Connectors	J1, J2 32 or 64 bit No rear I/O
Operating temperature range	0° – 70°C
Relative humidity	90 %, non-condensing
Geographic addressing	64-bit versions

Material:
Fibreglass epoxy to IEC 60 249 (type FR4)

Supply includes:
Backplane, fully populated.

Backplanes 3U for low profile bridge

Slots	Version	Model No. RP	
		32 bit	64 bit
2	S	3689.300 ¹⁾	3689.307
3	SE	3689.301 ¹⁾	3689.308
4	SBME	3689.302 ¹⁾	3689.309
5	SBME	3689.303	3689.310
6	SBME	3689.304 ¹⁾	3689.311
7	SBE	3689.305 ¹⁾	3689.312
8	S	3689.306 ¹⁾	3689.313

¹⁾ Delivery times available on request.

Backplanes 3.5U

Slots	Version	Model No. RP	
		32 bit	64 bit
2	SBE	–	3687.864
3	SE	3687.865	3686.578
4	SE	3687.863	3686.576
5	SE	3687.862	3686.575
6	SBME	3687.861	3686.548
7	SBE	3687.860	3686.547
8	S	3687.859	3686.546

S = Stand alone M = Middle segment
B = Beginning segment E = Ending segment

+ Accessories:

cPCI/cPCI bridge, RP 3686.571
(for 3.5U backplanes), see page 54
cPCI/cPCI low profile bridge
(for 3U backplanes), see page 54
Accessories for backplane mounting:
Conductive strips, see page 122
Insulating strips, see page 123



Front view 6.5U

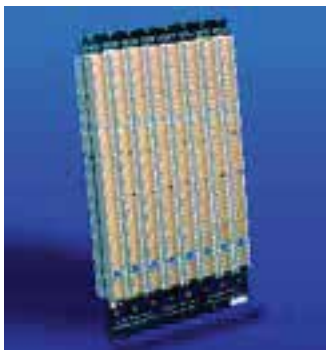

Rear view 6.5U

Backplanes 6U, 6.5U

Number of layers	8, 10 (with 6U)
Layer structure	2 GND layers
PCB thickness	3.2 mm
Data transfer rate	132/264 Mbytes/ 32, 64-bit version
Power inlets	6.5U: 2 – 4 slots: 1 x ATX connector 5 – 7 slots: 2 x ATX connector 8 slots: 3 x ATX connector 6 U: via screws and busbars
Control connector	+3.3 V, +5 V, +12 V, -12 V
VI/O (6U)	May be set to +5 V or +3.3 V
CPU slot	on right (left upon request)
Standards	PCI 2.1 (PCI Spec) PICMG 2.0 (CompactPCI) PICMG 2.1 (hot swap) IEEE 1101.1/10/11
Installation height	6.5U (284.3 mm), 6U
Distance between slots	4 HP
Connectors	J1, J2 32 or 64 bit J3, J4, J5 for rear I/O (64 bit only)
Operating temperature range	0° – 70°C
Relative humidity	90 %, non-condensing
Geographic addressing	64-bit versions

Material:
Fibreglass epoxy to IEC 60 249 (type FR4)

Supply includes:
Backplane, fully populated.

Backplanes 6U for low profile bridge

Slots	Version	Model No. RP	
		32 bit	64 bit
2	S	3689.314 ¹⁾	3689.321
3	SE	3689.315 ¹⁾	3689.322
4	SBME	3689.316 ¹⁾	3689.323
5	SBME	3689.317 ¹⁾	3689.324
6	SBME	3689.318 ¹⁾	3689.325
7	SBE	3689.319 ¹⁾	3689.326
8	S	3689.320 ¹⁾	3689.327

¹⁾ Delivery times available on request.

Backplanes 6.5U for low profile bridge

Slots	Version	Model No. RP
		64 bit
3	SE	3689.209
4	SE	3689.208
5	SBE	3689.207
6	SBME	3689.206
7	SBE	3689.205

S = Stand alone M = Middle segment
B = Beginning segment E = Ending segment

+ Accessories:

cPCI/cPCI low profile bridge, see page 54
Accessories for backplane mounting:
Conductive strips, see page 122
Insulating strips, see page 123
Stiffening kit: **RP 3688.088.**

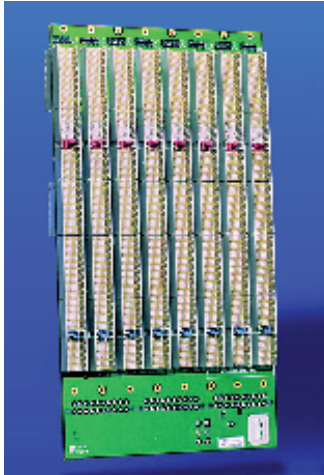

Front view

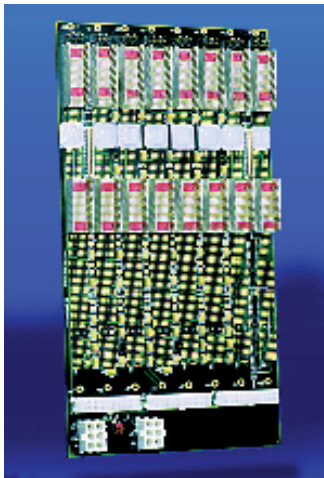

Rear view

Backplanes 7U with H.110

Number of layers	10
Layer structure	2 GND layers
PCB thickness	3.2 mm
Data transfer rate	132/264 MBytes/32, 64-bit (for cPCI)
Power inlets	up to 4 slots 1 x ATX connector 5 – 7 slots: 2 x ATX connector 8 slots: 3 x ATX connector
CPU slot	Right
Standards	PCI 2.1 (PCI specification) PICMG 2.0 (CompactPCI) PICMG 2.1 (hot swap) PICMG 2.5 (cPCI Computer Telephony) IEEE 1101.1/10/11
Installation height	7U
Distance between slots	4 HP
Connectors	J1, J2 64 bit J3 rear I/O J4 H.110
Operating temperature range	0° – 70°C
Relative humidity	90 %, non-condensing
Geographic addressing	Yes

J4 pin assignment

No.	Row Z	Row A	Row B	Row C	Row D	Row E	Row F
25	NP	SGA4	SGA3	SGA2	SGA1	SGA0	FG
24	NP	GA4	GA3	GA2	GA1	GA0	FG
23	NP	+12 V	/CT reset	/CT EN	-12 V	CT_MC	FG
22	NP	PFSO#	RSVD	RSVD	RSDV	RSDV	FG
21	NP	-SEL Vbat	PFS1#	RSDV	RSDV	SEL VbatRtn	FG
20	NP	NP	NP	NP	NP	NP	NP
19	NP	NP	NP	NP	NP	NP	NP
18	NP	VRG	IN/C	IN/C	IN/C	VRGRtn	NP
17	NP	NP	NP	NP	NP	NP	NP
16	NP	NP	NP	NP	NP	NP	NP
15	NP	-Vbat	IN/C	IN/C	IN/C	Vbat Rtn	NP
14							
13							
12							
11	NP	CT_D29	CT_D30	CT_D31	V(I/O)	/CT_FRAME	GND
10	NP	CT_D27	+3.3 V	CT_D28	+5 V	/C_FRAME B	GND
9	NP	CT_D24	CT_D25	CT_D26	GND	/FR_COMP	GND
8	NP	CT_D21	CT_D22	CT_D23	+5 V	CT_C8 A	GND
7	NP	CT_D19	+5 V	CT_D20	GND	CT_C8 B	GND
6	NP	CT_D16	CT_D17	CT_D18	GND	CT_NETREF	GND
5	NP	CT_D13	CT_D14	CT_D15	+3.3 V	CT_NETREF	GND
4	NP	CT_D11	+5 V	CT_D12	+3.3 V	SCLK	GND
3	NP	CT_D8	CT_D9	CT_D10	GND	SCLK-D	GND
2	NP	CT_D4	CT_D5	CT_D6	CT_D7	GND	GND
1	NP	CT_D0	+3.3 V	CT_D1	CT_D2	CT_D3	GND

Key to J4 pin assignment

CT_name	= H.110 TDM bus signals
+5 V	= +5 V power
+3.3 V	= +3.3 V power
GND	= logic ground
V(I/O)	= I/O cell power
FG	= frame ground
RSVD	= reserved for future use
NP	= a pin and pad REQUIRED to be not populated to meet safety regulations
IN/C	= no connect required for safety agency insulation requirements

Material:

Fibreglass epoxy to IEC 60 249 (type FR4)

Supply includes:

Backplane, fully populated.

H.110 connected to system slot

Slots	cPCI version	H.110 version	Model No. RP
3	SE	SE	3688.508
4	SE	SBME	3688.507
5	SE	SBME	3687.875
6	SBME	SBME	3687.874
7	SBE	SBME	3687.873
8	S	SBME	3687.877

H.110 not connected to system slot

Slots	cPCI version	H.110 version	Model No. RP
3	S	S	3688.427
4	S	SB	3688.426
5	S	SB	3688.506
6	SB	SB	3688.505
7	SBE	SB	3688.504
8	S	SB	9805.494

Extendible with low profile bridge.

S = Stand alone
B = Beginning segment
M = Middle segment
E = Ending segment

KEY AREA

-SELVbat	= short loop battery
SELVbatRtn	= short loop battery return
-Vbat	= telecom power distribution bus
VbatRtn	= return bus pin for -Vbat
SGA0-SGA4	= shelf enumeration bus signals
GA0-GA4	= slot ID signals: not bussed
VRG	= bus for ringing voltage
VRGRtn	= bus for ringing voltage
PFSO#-PFS1#	= busses for power fail sense
KEY AREA	= area utilized for key

Backplanes

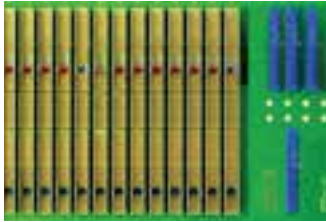

Backplanes 7U, Switch Fabric to PICMG 2.16

The "Switch Fabric" backplanes comply with PICMG specification 2.16. They support telephony applications and a high level of system availability in which cPCI is combined with Ethernet for high-speed applications.

Power inlets	Positronic 47-pole, or ATX
CPU slot	Right
Standards	PCI 2.1 (PCI specification) PICMG 2.0 (CompactPCI) PICMG 2.1 (hot swap) PICMG 2.5 (cPCI Computer Telephony) IEEE 1101.1/10/11 PICMG 2.16
Installation height	7U (6U for RP 3686.396 and RP 3689.186)
Distance between slots	4 HP
Operating temperature range	0° – 70°C
Relative humidity	90 %, non-condensing
Geographic addressing	Yes

Material:
Fibreglass epoxy to IEC 60 249 (type FR4)

Supply includes:
Backplane, fully populated.

Technical specifications:

- 7U, 84 HP/32 HP
- Comply with PICMG 2.1, fully hot swap-compatible
- Selectable voltage V (I/O) (3.3 V or 5 V) when configured for 33 MHz CompactPCI
- Integral Schottky diode bus terminator
- Prepared for up to four backplane reinforcements to avoid bending during card insertion
- H.110 CT bus complies with specification PICMG 2.5 at all node slots
- Support 8 HP CPU boards when one node slot is relinquished
- Twin redundant support for Switch Fabric (2 fabric and 12 basic nodes), as specified in PICMG 2.16
- Support rear transition modules with all board slots
- Configurable for power supply with either two 6U x 8 HP, three 6U x 4 HP, three 3U x 4 HP, three 3U x 8 HP or four 3U x 4 HP
- All power supply slots conform to PICMG 2.11
- Power supply connectors for H.110-Vbat, -SELVbat and VRG power signals
- ATX power connector for auxiliary power inlet/outlet
- Two fan power connectors for 12 V and system management support
- System control bus (SMBus) complies with PICMG 2.9 and supports all boards, power supplies, power entry modules, fans and alarm cards
- Support of I²C bridge function on the alarm card for >19 SMBus nodes

Width	Number of slots	Description of slots	Model No. RP
32 HP	8	1 Fabric slot 6 node slots with cPCI and H.110 1 host slot	3689.188
		see RP 3689.188, but without H.110	3686.414
64 HP	16	1 Fabric slot 6 node slots with cPCI and H.110 1 host slot 1 Fabric slot 6 node slots with cPCI and H.110 1 host slot 3 slots for power supplies	3686.396
		see RP 3686.396, but without H.110	3689.186
84 HP	21	7 node slots with cPCI and H.110 1 host slot 1 node slot with H.110 without cPCI 1 Fabric slot 7 node slots with cPCI and H.110 1 host slot 1 node slot with H.110 without cPCI 1 Fabric slot 1 Alarm slot	3686.397
		see RP 3686.397, but without H.110	3689.190
		see RP 3686.397, but without cPCI	3689.191

Front

1	System (CPU) card	12	Node card
2	Node card	13	Node card
3	Node card	14	Node card
4	Node card	15	Node card
5	Node card	16	Fabric card B
6	Node card	17	Blank
7	Node card	18	Power supply 1
8	Fabric card A	19	Power supply 2
9	System (CPU) card	20	Power supply 3
10	Node card	21	Blank
11	Node card		

Rear

1	System RTC	12	Node RTC
2	Node RTC	13	Node RTC
3	Node RTC	14	Node RTC
4	Node RTC	15	Node RTC
5	Node RTC	16	Fabric B RTC
6	Node RTC	17	Alarm card
7	Node RTC	18	PEM 1
8	Fabric A RTC	19	
9	System RTC	20	PEM 2
10	Node RTC	21	
11	Node RTC		

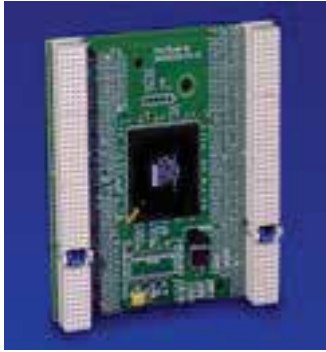

1



2

Modular cPCI bridge

cPCI bridge may be connected to the rear to extend the bus by a maximum of 7 additional slots. The cPCI bridge handles all communications between the individual bus segments. The front slots are freely available for cPCI boards. It supports the 64-bit PCI bus and may be used in conjunction with cPCI backplanes 3.5 U and 6.5U.

Technical specifications:

- May be connected to the rear of cPCI backplanes
- PCI bridge
- 64 bit "high performance" Intel 21154
- For use with Pixus cPCI backplanes (not with low profile backplanes)
- Corresponding to PCI specifications 2.1
- Conforms to cPCI
- cPCI bridge connects cPCI backplanes from right to left (as viewed from the front) – i.e. the "left-hand" connector accommodates the host board

Material:

Fibreglass epoxy to IEC 60 249 (FR4)

Supply includes:

Bridge, fully populated.

1 Front view

2 Rear view

Description	Model No. RP
64-bit cPCI bridge	3686.571

Extended delivery times.

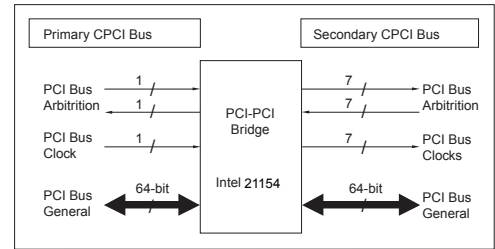

1



2

Modular low profile bridge

cPCI bridge may be connected to the rear to extend the bus by a maximum of 7 additional slots, without any loss of slots: Optionally available as a 32-bit or 64-bit version. Only suitable for use in conjunction with low profile backplanes.

Material:

Fibreglass epoxy to IEC 60 249 (FR4)

Supply includes:

Bridge, fully populated.

1 32-bit version

2 64-bit version

Version	Bit	Model No. RP
left-right	32	3689.210
right-left	32	3689.211
left-right	64	9810.637
right-left	64	9812.625
right-left	64	3687.880¹⁾

¹⁾ For backplane H.110

Backplanes

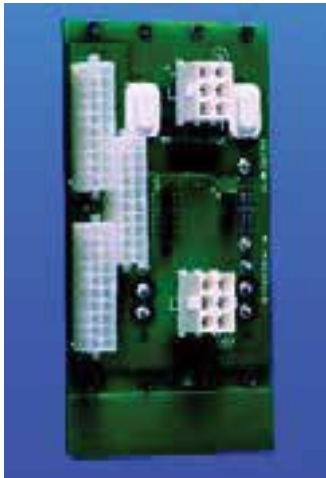

Power supply board 3U/3/5U

- Board 3U/3.5U (0.5U may be broken off), 8HP, 16H, 24HP
- For use in conjunction with cPCI backplanes
Accommodation of 1/2/3 power supplies with up to 250 W
- AC/DC connection is made via two 3-pole connectors
- Outgoing voltages to supply one or more cPCI backplanes are available at ATX-compatible connectors
- Complies with PICMG 2.0, PICMG 2.11
- **Technical specifications:**
Accommodation of 1/2/3 cPCI power supplies with up to 250 W.
The second power supply unit may be used for redundancy (with power distribution) or, via parallel connection, to increase the current.

Input voltages:

- AC input via 2 x 3-pole AMP Mate-N-Lock (AMP # 350732-1), connector J12
- Connected via pin 45, 46, 47, type Positronic
- Maximum current load per pin is 25 A, matching counter-connector for cable harness AMP # 350715
- DC input via 2 x 3-pole AMP Mate-N-Lock (AMP # 350732-1), connector J5 connected via pin 46, 47, type Positronic
- Maximum current load per pin is 25 A, matching counter-connector for cable harness AMP # 350715
- Output voltage:
- Three 20-pole ATX-compatible connectors for ATX cable harness (connection of power supply board to cPCI backplane)

Description	HP	Model No. RP
3U for 1 x plug-in power supply with Positronic connector, 47-pin	8	9905.105
3U board for 3 x plug-in power supplies with Positronic connector, 47-pin	24	9904.131
3.5U board for 2 x plug-in power supplies with Positronic connector, 47-pin	16	3688.603
ATX (12") cable harness		9810.337
ATX (16") cable harness		3686.570
ATX (20") cable harness		9810.338

Material:

Fibreglass epoxy to IEC 60 249 (FR4)

Supply includes:

Board, fully populated.

Note:

Plug-in power supplies, see page 75

RP 3688.603

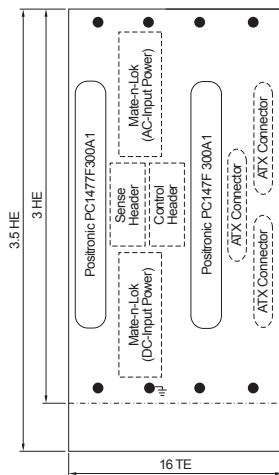

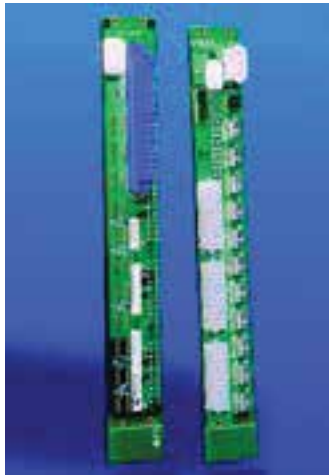

**Power supply board
6U/6.5U, 8HP**

- Board 6U/6.5U (0.5U may be broken off), 8 HP
- For use in conjunction with cPCI backplanes 3.5U, 6.5U, H.110
- Accommodation of a power supply of up to 500 W
- AC/DC connection is made via 3-pole connectors
- Outgoing voltages to supply one or more cPCI backplanes are available at 3 ATX-compatible connectors or at special power terminals
- Complies with PICMG 2.0, PICMG 2.11

Technical specifications:

Accommodation of a 6U cPCI power supply with up to 500 W.

Input voltages:

- AC input via 3-pole AMP Mate-N-Lock connector
Max. current capacity per pin 25 A
- DC input via 3-pole AMP Mate-N-Lock connector
Max. current capacity per pin 25 A

Output voltage:

- Three 20-pole ATX-compatible connectors for ATX cable harness (connection of power supply board to cPCI backplane) and/or special power terminals

Description	Model No. RP
1 x plug-in power supply with Positronic connector, 47-pin	3688.607
ATX (12") cable harness	9810.337
ATX (16") cable harness	3686.570
ATX (20") cable harness	9810.338

Extended delivery times.

Material:

Fibreglass epoxy to IEC 60 249 (FR4)

Supply includes:

Board, fully populated.

Note:

Plug-in power supplies, see page 75

RP 3688.607

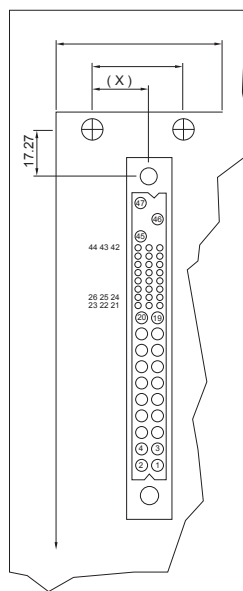
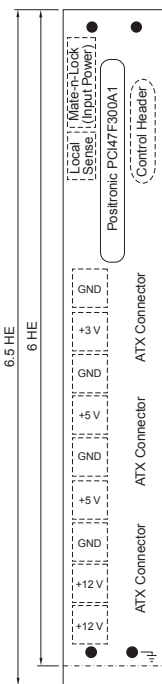

Power Supply Boards

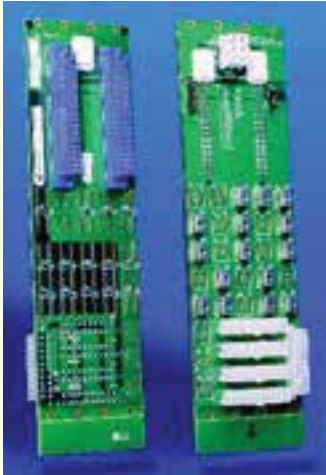

Power supply board 6U/6.5U, 16HP

- Board 6U/6.5U (0.5U may be broken off), 16HP
- For use in conjunction with Pixus cPCI backplanes
- Accommodation of two power supplies with up to 500 W
- AC/DC connection is made via two 2 x 3-pole connectors
- Outgoing voltages to supply one or more cPCI backplanes are available at 5 ATX-compatible connectors or at special power terminals
- Complies with PICMG 2.0, PICMG 2.11

Technical specifications:

Accommodation of 2 x 6U cPCI power supplies of up to 500 W

Input voltages:

- AC input via 2 x 3-pole AMP Mate-N-Lock connector
Max. current capacity per pin 25 A
- DC input via 2 x 3-pole AMP Mate-N-Lock connector
Max. current capacity per pin 25 A

Output voltage:

- Five 20-pole ATX-compatible connectors for ATX cable harness (connection of power supply board to cPCI backplane) and/or special power terminals

Description	Model No. RP
Board for 2 x plug-in power supplies with Positronic connector, 47-pin	3688.608
ATX (12") cable harness	9810.337
ATX (16") cable harness	3686.570
ATX (20") cable harness	9810.338

Extended delivery times.

Material:

Fibreglass epoxy to IEC 60 249 (FR4)

Supply includes:

Board, fully populated.

Note:

Plug-in power supplies, see page 75

RP 3688.608

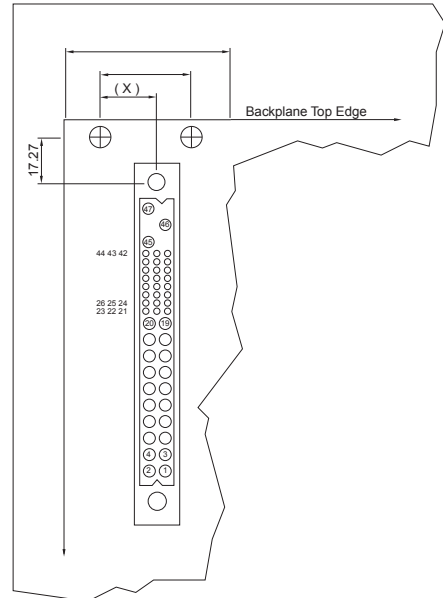
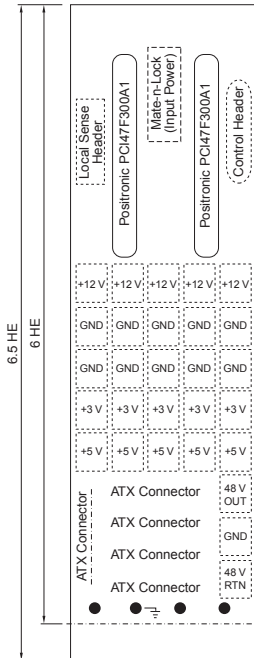

Backplanes, Horizontal



Backplane 9U Monolithic with power supply connector

Material:
Fibreglass epoxy to IEC 60 249 (FR4)

Supply includes:
Board, fully populated.

Slots	Connector Positronic 47-pin	ATX	Model No. RP
2 ¹⁾	1	0	3689.329
4	2	1	3689.330
6	3	1	3689.331
8	4	1	3689.332

System slot on right 64 bit with rear I/O, V I/O: +5.0 V.
H.110 not connected to system slot.

¹⁾ Without H.110

Rackmount Systems, Slim-Box Vario 2U, 4U

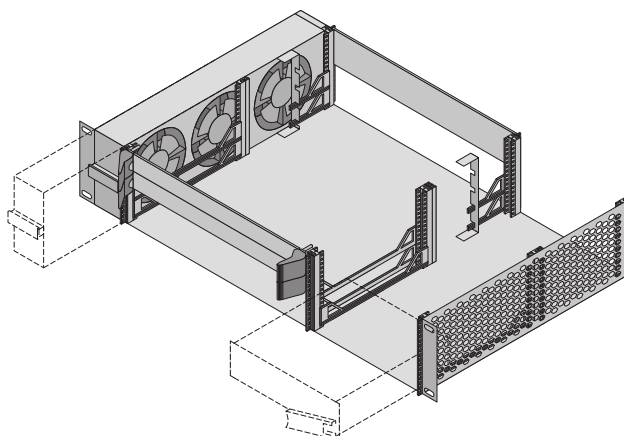

Technical specifications:

- Rack-mount enclosure 482.6 mm (19") for the horizontal installation of boards
- Front and rear 2 slots per U for VME64x boards
- Enclosure cooling from left to right
- EMC and ESD-compatible design
- Includes fan tray
- Complies with IEC 60 297-3-101, -102, -103

Material:

Sheet steel, spray-finished (black)

Note:

In addition to the pre-configured systems shown here, individual solutions are also easily achieved. The basic enclosure provides the basis, and is variably populated with the required components.

Slim-Box Vario VME64x		2U		4U	
For PCBs		6U x 160		3U x 160	
Model No. RP complete system		VME64x without rear I/O 9912.354		VME64x without rear I/O 9912.484	
Item	Package description	Model No. RP		Model No. RP	
1	Basic enclosure, EMC, fully assembled, 300 mm deep, black	1	9912.048	1	9912.461
2	ATX PSU control module, 3U x 4 HP, EMC (kit)	1	9913.998	1	9913.998
3	Rear panel for AC/DC ATX PSU (200/300 W), 3 U x 8 HP (kit)	1	9912.050	1	9912.921
4	Slim drive support (kit)	1	9912.289	–	9912.463
5	Rails for standard 3U components (kit)	–	9912.056	1	9912.466
6	Fan tray with fan filter and 12V DC fan, fully wired	1	9909.191	1	9912.475
Power supplies					
7	ATX PSU, AC/DC, wide range, 1U, 200 W	1	9907.585	–	–
8	ATX PSU, AC/DC, wide range, 1U, 300 W	–	–	1	9907.584
Guide rails					
9	Keyable guide rails, 160 mm, grey	8	3684.669	16	3684.669
10	ESD board contact spring	8	3684.978	32	3684.978
11	ESD contact spring for front panel	4	3684.979	16	3684.979
12	Guide rails 4.4" for drive support	2	3686.990	–	–
Filler panels					
13	Filler panel, EMC, 3U x 4 HP (kit)	–	–	1	3685.178
14	Filler panel, EMC, 3U x 8 HP (kit)	1	3685.182	1	3685.182
15	Filler panel, EMC, 3U x 16 HP (kit)	–	–	2	3685.348
16	Filler panel, EMC, 6U x 16 HP (kit)	1	3685.349	–	–
17	Filler panel, EMC, 6U x 28 HP (kit)	–	–	1	3684.260
Backplanes					
18	VME64x backplane, with P0, 6U, 4 Slot, active/passive	1	9912.362	–	–
19	VME64x backplane, with P0, 6U, 8 Slot, active/passive	–	–	1	9912.413

Rackmount Systems, Ripac 3U, 5 lots/4U, 7 slots Horizontal

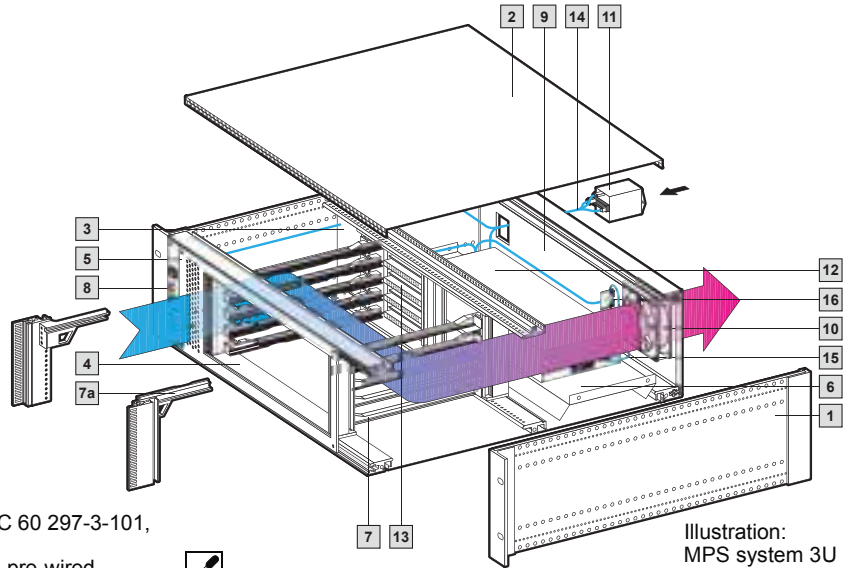

Technical specifications:
Subrack, 405 mm deep, for installation in 482.6 mm (19") enclosures or cases. Prepared to accommodate VMEbus boards and drives. Includes MPS Monitoring,

Complies with IEC 60 297-3-101, -102, -103.
Fully assembled, pre-wired and tested.

Pixus service:

Modifications or individual system solutions can be provided at short notice.

Illustration: MPS system 3U

Pixus' system specialists will assist you with planning and configuration.

U	3	3	4	4	Page
Side panel depth mm	405	405	405	405	
Wiring space (depth in mm)	210	210	210	210	
For PCBs	6U x 160 mm	6U x 160 mm	6U x 160 mm	6U x 160 mm	
MPS system Model No. RP for VME	9910.949	–	9910.954	–	
MPS system Model No. RP for VME64x	–	9910.950	–	9910.955	

Mechanical supply includes						
Description	Material	Qty.				
1 Ripac basic subrack system (side panels, horizontal rails, flanges, EMC gaskets)	Aluminium, clear-chromated/ stainless steel	1	1	1	1	–
2 Top and bottom covers, solid	Aluminium	2	2	2	2	134
3 Air partition	Aluminium	1	1	1	1	83
4 Horizontal mounting kit	Aluminium, clear-chromate	1	1	1	1	126
5 Trim frame for horizontal mounting kit	2.5 mm aluminium, clear-chromated	1	1	1	1	127
6 Mounting base for power supply unit	2 mm aluminium, anodised	1	1	1	1	–
EMC shielding plate for fan	Aluminium, clear-chromated	1	1	1	1	86
7 Guide rails	Polycarbonate UL 94-V0	10	–	14	–	127
7a Plastic guide rails, keyable	Polycarbonate UL 94-V0	–	10	–	14	128
8 EMC front panel 3U or 4 U/5 HP, with MPS monitoring	2.5 mm aluminium, clear-chromated	1	1	1	1	–
9 EMC rear panel 3U/84 HP with fan and connector cut-out	2.5 mm aluminium, clear-chromated	1	1	–	–	–
EMC rear panel 4U/84 HP with fan and connector cut-out	2.5 mm aluminium, clear-chromated	–	–	1	1	–

Electrical/electronic supply includes						
Description	Technical specifications					
10 DC fan	12 V DC, 48 m ³ /h per fan (UL, CSA, VDE) optionally speed-controlled	1	1	1	1	85
11 IEC filtered mains inlet	6 A (VDE, UL, CSA)	1	1	1	1	–
12 Switch mode power supply unit	250 W, 5 V/35 A, +12 V/8 A, –12 V/8 A (VDE, UL, CSA)	1	1	1	1	–
13 VME backplane	J1, 5 slots, IN-board, passive, ADC	1	–	–	–	67
VME64x backplane	J1/J2, 5 slots (without P0)	–	1	–	–	66
VME backplane	J1, 7 slots, IN-board, passive, ADC	–	–	1	–	68
VME64x backplane	J1/J2, 7 slots	–	–	–	1	66
LED display module for MPS monitoring	for +5 V, ±12 V, fan failure	1	1	1	1	–
14 AC cable harness	–	■	■	■	■	–
15 DC cable harness	–	■	■	■	■	–
16 Fan module for DC fan	–	1	1	1	1	–

Rackmount Systems, Ripac 4U/7U, 12 slots

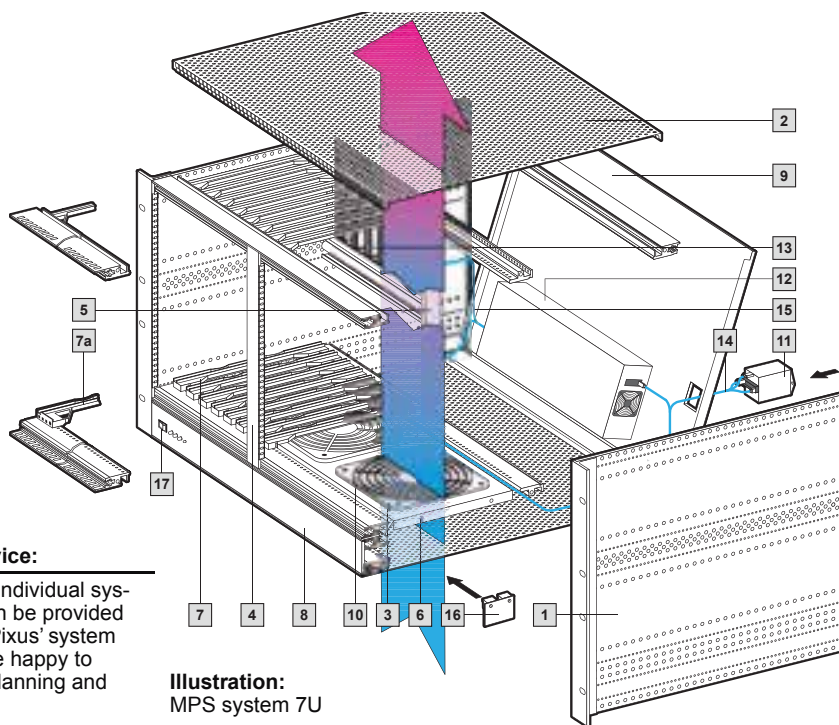

Technical specifications:
 Subrack, 405 mm deep, for installation in 482.6 mm (19") enclosures or cases. Prepared to accommodate VMEbus boards and drives. Includes MPS Monitoring Complies with IEC 60 297-3-101, -102, -103. Fully assembled, pre-wired and tested.

Pixus service:
 Modifications or individual system solutions can be provided at short notice. Pixus' system specialists will be happy to assist you with planning and configuration.

Illustration:
 MPS system 7U

U	4 (3 + 1)	7 (6 + 1)	7 (6 + 1)	Page
Side panel depth mm	405	405	405	
Wiring space (depth in mm)	210	210	210	
For PCBs	3U x 160 mm	3U/6 U x 160 mm		
MPS system Model No. RP for VME	9909.484	9910.956	–	
MPS system Model No. RP for VME64x	–	–	9910.957	

Mechanical supply includes

Description	Material	Qty.			
1 Ripac basic subrack system (side panels, horizontal rails, flanges, EMC gaskets)	Aluminium, clear-chromated/stainless steel	1	1	1	–
2 Top and bottom covers, vented	Aluminium	2	2	2	134
3 Finger guard	Polyamide	3	3	3	86
4 EMC front panel, 6U/4 HP (with 7U)	Aluminium, clear-chromated	–	1	–	–
5 Support, vertical (with 7U)	Aluminium, clear-chromated	–	1	–	126
6 Fan mounting plate	1 mm aluminium, anodised	1	1	1	82
7 Guide rails	Polycarbonate UL 94-V0	24	24	–	127
7a Plastic guide rails, keyable	Polycarbonate UL 94-V0	–	–	24	128
8 EMC front panel 1U/84 HP for switches/LED	2.5 mm aluminium, clear-chromated	1	1	1	–
Rear panel 4U/84 HP, horizontally hinged with connector cut-out	2.5 mm aluminium, clear-chromated	1	–	–	–
9 EMC rear panel 7U/84 HP, horizontally hinged with connector cut-out	2.5 mm aluminium, clear-chromated	–	1	1	–

Electrical/electronic supply includes

Description	Technical specifications	Qty.			
10 DC fan	12 V DC, 140 m³/h per fan (VDE, UL, CSA) optionally speed-controlled	3	3	3	85
11 IEC filtered mains inlet	6 A (VDE, UL, CSA)	1	1	1	–
12 Switch mode power supply unit	400 W, 5 V/80 A, +12 V/8 A, –12 V/8 A (VDE, UL, CSA)	1	1	–	–
Open frame power supply (RP 3687.695)	400 W, 3.3 V/25 A, +5 V/25 A, +12 V/8 A, –12 V/7 A (VDE, UL, CSA)	–	–	1	–
13 VME backplane	J1, 12 slots, IN-board, passive, ADC	1	1	–	67
VME64x backplane	J1/J2, 12 slots	–	–	1	66
17 LED display module for MPS monitoring	for (3.3 V), +5 V, ±12 V, fan failure	1	1	1	–
14 AC cable harness	–	■	■	■	–
15 DC cable harness	–	■	■	■	–
16 Fan module for DC fan	–	1	1	1	–

Rackmount Systems, Ripac 7U, 12 slots

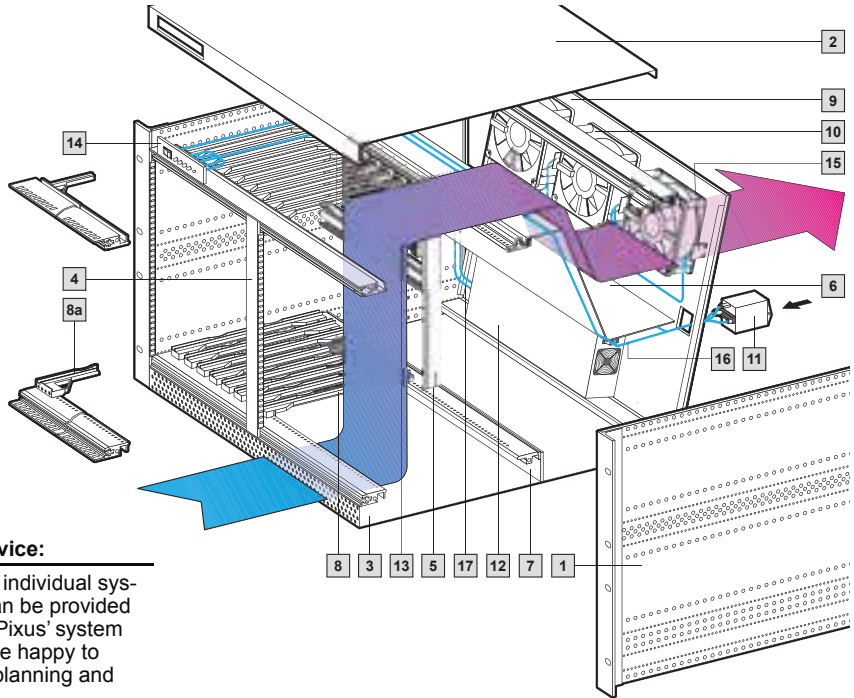

Technical specifications:
 Subrack, 405 mm deep, for installation in 482.6 mm (19") enclosures or cases. Prepared to accommodate VME-bus boards and drives. Includes MPS Monitoring. Complies with IEC 60 297-3-101, -102, -103. Fully assembled, pre-wired and tested.

 **Pixus service:**
 Modifications or individual system solutions can be provided at short notice. Pixus' system specialists will be happy to assist you with planning and configuration.

U	7 (6 + 2 x 1/2)	7 (6 + 2 x 1/2)	Page
Side panel depth mm	405	405	
Wiring space (depth in mm)	210	210	
For PCBs	6U x 160 mm	6U x 160 mm	
MPS system Model No. RP for VME	9910.958	–	
MPS system Model No. RP for VME64x	–	9910.959	

Mechanical supply includes

Description	Material	Qty.		
1 Ripac basic subrack system (side panels, horizontal rails, flanges, EMC gaskets)	Aluminium, clear-chromated/ stainless steel	1	1	–
2 Cover with 1/2 U edge fold and cut-outs for switches/LEDs	Aluminium	1	1	137
3 Bottom cover with 1/2U edge fold, ventilated at the front	Aluminium	1	1	137
4 EMC front panel, 6U/4 HP	2.5 mm aluminium, clear-chromated	1	–	–
EMC shielding plate for fan	Aluminium, clear-chromated	3	3	86
5 Vertical support	Aluminium, clear-chromated	1	–	82
6 Air baffle	1 mm aluminium, anodised	1	1	83
7 Air block panel, 1/2U	Epoxy	1	1	83
8 Guide rails	Polycarbonate UL 94-V0	24	–	127
8a Plastic guide rails, keyable	Polycarbonate UL 94-V0	–	24	128
9 EMC rear panel, horizontally hinged, 7U, with fan and connector cut-out	2.5 mm aluminium, clear-chromated	1	1	–

Electrical/electronic supply includes

Description	Technical specifications			
10 DC fan	12 V DC, 140 m³/h per fan (UL, CSA, VDE) optional speed control	3	3	85
11 IEC filtered mains inlet	6 A (VDE, UL, CSA)	1	1	–
12 Switch mode power supply unit	400 W, 5 V/80 A, +12 V/8 A, –12 V/8 A (VDE, UL, CSA)	1	–	–
Open frame power supply (RP 3687.695)	400 W, 3.3 V/25 A, 5 V/25 A, 12 V/8 A, –12 V/7 A (VDE, UL, CSA)	–	1	–
13 VME backplane	J1, 12 slots, IN-board passive, ADC	1	–	67
VME64x backplane	J1/J2, 12 slots (without P0)	–	1	66
14 LED display module for MPS monitoring	for (3.3 V), +5 V, ±12 V, fan failure	1	1	–
15 Fan module for DC fan	–	1	1	–
16 AC cable harness	–	■	■	–
17 DC cable harness	–	■	■	–

Rackmount Systems, Ripac 9U, 12 slots, with RiCool radial fan

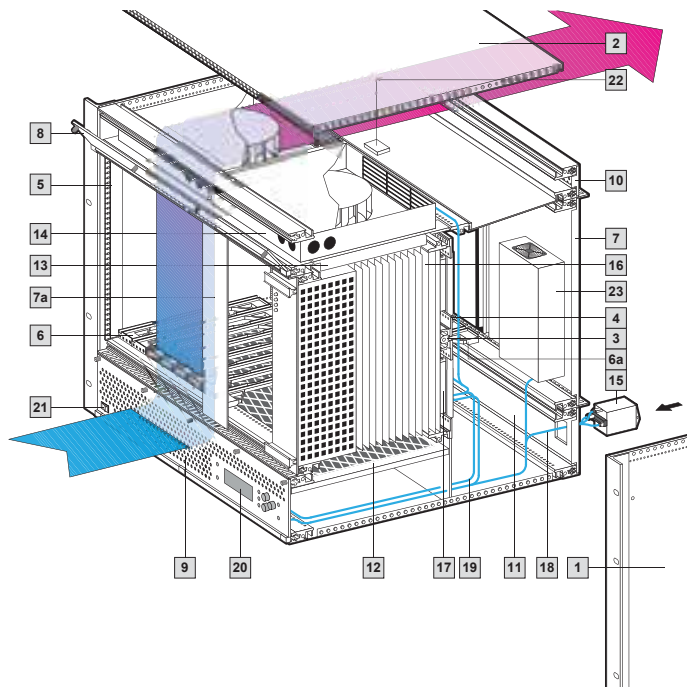

Technical specifications:
 Subrack, 290,5 mm deep, for installation in 482.6 mm (19") enclosures or cases. Prepared to accommodate VMEbus boards and drives. Includes MPS Monitoring Complies with IEC 60 297-3-101, -102, -103.

Fully assembled, pre-wired and tested.

 **Pixus service:**
 Modifications or individual system solutions can be provided at short notice. Pixus' system specialists will be happy to assist you with planning and configuration.

U	9 (6 + 2 x 1 1/2)	Page
Side panel depth mm	290.5	
Wiring space (depth in mm)	85.5	
For PCBs	6U x 160 mm	
MPS system Model No. RP for VME64x	9910.960	

Mechanical supply includes

Description	Material	Qty.	
1 Ripac basic subrack system (side panels, horizontal rails, flanges, EMC gaskets)	Aluminium, clear-chromated/ stainless steel	1	-
2 Top and bottom covers, solid	1 mm aluminium	2	135
3 Centre horizontal rail 12 HP	1 mm aluminium, clear-chromated	1	-
4 Z rail 12 HP	Aluminium, clear-chromated	4	-
5 EMC contact strip	Aluminium, clear-chromated	2	125
6 Plastic guide rails, keyable	Polycarbonate UL 94-V0	24	128
Guide rails, keyable, green, for power supply	Polycarbonate UL 94-V0	2	129
6a Guide rails for I/O transition modules	Polycarbonate UL 94-V0	24	-
7 EMC rear panel 6U/36 HP	2.5 mm aluminium, clear-chromated	1	-
7a EMC front panel	2.5 mm aluminium, clear-chromated	1	-
8 Front panel 1 1/2U/84 HP, horizontally hinged	2.5 mm aluminium, clear-chromated	1	-
9 Front panel 1 1/2U/84 HP, vented, horizontally hinged, for MPS monitoring	2.5 mm aluminium, clear-chromated	1	-
10 EMC rear panel 1 1/2U/84 HP, vented	2.5 mm aluminium, clear-chromated	1	-
11 EMC rear panel, 1 1/2U/84 HP, with connector cutout	2.5 mm aluminium, clear-chromated	1	-
12 Filter mat 160 mm, 84 HP, for slide-in attachment	-	1	-
13 Mounting plate for RiCool	1 mm sheet steel, zinc-plated, passivated	1	-

Electrical/electronic supply includes

Description	Technical specifications		
14 RiCool DC fan, individually removable. Including fault alarm signal, speed control	24 V DC, 204 m³/h, 48 W	2	-
15 IEC filtered mains inlet	6 A (VDE, UL, CSA)	1	-
16 Power supply, plug-in, 6 U/12 HP	270 W, 5 V/35 A, +12 V/6 A, -12 V/2 A (VDE, IEC)	1	-
VME64x backplane	J1/J2, 12 slots (without P0)	1	66
17 Female connector for power supply unit	H15	2	-
18 AC cable harness	-	■	-
19 DC cable harness	-	■	-
20 Display module	for +5 V, ±12 V, fan failure	1	-
21 Mains switch	-	1	-
22 Monitoring module for RiCool and backplane	-	2	-
23 Power supply for RiCool	-	1	-
Temperature module	-	1	-

General technical specifications VMEbus

The VMEbus, based on standard IEEE 1014 and IEC 821, has become established worldwide as an industry standard. The VME64 is a new addition to the VME family to ANSI/VITA 1-1994 and supports 64-bit data traffic. The VME64x extends the VME family to ANSI/VITA 1.1-1997 and is available with the optional 133-pole 2 mm connector J0. 160-pole connectors are used with VME64x. This system remains backward compatible, so that assemblies with 96-pole connectors to IEC 60 603-2 may still be used. All Pixus VMEbus boards are of a **HIGH SPEED DESIGN**. Minimal reflections are achieved, due to even surge impedance of the signal track. The consistent shielding of every signal track ensures minimum coupling and hence guarantees interference-free operation even when extended to 64 bit mode with the **2e protocol** (160 Mbyte/s).

Daisy-chain circuit

With the daisy-chain circuit, a distinction is made between manual daisy-chaining and automatic daisy-chaining. Automatic daisy-chaining renders the connection of jumpers superfluous, and users are saved the time-consuming task of insertion and extraction. What is more, possible misconnections are avoided. Automatic daisy-chaining can be achieved in two ways. Pixus VME backplanes are generally supplied with automatic daisy-chaining.

Termination

In order to avoid malfunctions on signal tracks that may arise as a result of reflections on the exposed track end, these must be terminated with the VMEbus. Termination may be either ON-/IN-board (on the backplane) or OFF-board (external). With regard to the type of termination, a distinction is made between passive and active termination. The benefit of active termination lies in the lower closed-circuit current consumption. Passive termination is distinguished by superior frequency response and a broader temperature range.

Pin assignment J1 and J2

Pin assignment J1

Pin assignment for J1 connector VME64x					
Pin no.	Row z	Pin assignment for J1 connector VME			
		Row a	Row b	Row c	Row d
1	MPR	D00	BBSY	D08	VPC
2	GND	D01	BCLR	D09	GND
3	MCLK	D02	ACFAIL	D10	+ V1
4	GND	D03	BG0IN	D11	+ V2
5	MSD	D04	BG0OUT	D12	RsvU
6	GND	D05	BG1IN	D13	- V1
7	MMD	D06	BG1OUT	D14	- V2
8	GND	D07	BG2IN	D15	RsvU
9	MCTL	GND	BG2OUT	GND	GAP
10	GND	SYSCLK	BG3IN	SYSFAIL	GAO
11	RTRY1	GND	BG3OUT	BERR	GA1
12	GND	DS1	BR0	SYSRESET	+3.3 V
13	RsvBus	DS0	BR1	LWORD	GA2
14	GND	WRITE	BR2	AM5	+3.3 V
15	RsvBus	GND	BR3	A23	GA3
16	GND	DTACK	AM0	A22	+3.3 V
17	RsvBus	GND	AM1	A21	GA4
18	GND	AS	AM2	A20	+3.3 V
19	RsvBus	GND	AM3	A19	RsvBus
20	GND	IACK	GND	A18	+3.3 V
21	RsvBus	IACKIN	SERCLK (1)	A17	RsvBus
22	GND	IACKOUT	SERDAT (1)	A16	+3.3 V
23	RsvBus	AM4	GND	A15	RsvBus
24	GND	A07	IRQ7	A14	+3.3 V
25	RsvBus	A06	IRQ6	A13	RsvBus
26	GND	A05	IRQ5	A12	+3.3 V
27	RsvBus	A04	IRQ4	A11	LI/I
28	GND	A03	IRQ3	A10	+3.3 V
29	SBB	A02	IRQ2	A09	LI/O
30	GND	A01	IRQ1	A08	+3.3 V
31	SBA	-12 V	+5 V STDBT	+12 V	GND
32	GND	+5 V	+5 V	+5 V	VPC

Pin assignment J2

Pin assignment for J2 connector VME64x					
Pin no.	Row z	Pin assignment for J2 connector VME			
		Row a	Row b	Row c	Row d
1	UD	User def.	+5 V	User def.	UD
2	GND	User def.	GND	User def.	UD
3	UD	User def.	Retry	User def.	UD
4	GND	User def.	A24	User def.	UD
5	UD	User def.	A25	User def.	UD
6	GND	User def.	A26	User def.	UD
7	UD	User def.	A27	User def.	UD
8	GND	User def.	A28	User def.	UD
9	UD	User def.	A29	User def.	UD
10	GND	User def.	A30	User def.	UD
11	UD	User def.	A31	User def.	UD
12	GND	User def.	GND	User def.	UD
13	UD	User def.	+5 V	User def.	UD
14	GND	User def.	D16	User def.	UD
15	UD	User def.	D17	User def.	UD
16	GND	User def.	D18	User def.	UD
17	UD	User def.	D19	User def.	UD
18	GND	User def.	D20	User def.	UD
19	UD	User def.	D21	User def.	UD
20	GND	User def.	D22	User def.	UD
21	UD	User def.	D23	User def.	UD
22	GND	User def.	GND	User def.	UD
23	UD	User def.	D24	User def.	UD
24	GND	User def.	D25	User def.	UD
25	UD	User def.	D26	User def.	UD
26	GND	User def.	D27	User def.	UD
27	UD	User def.	D28	User def.	UD
28	GND	User def.	D29	User def.	UD
29	UD	User def.	D30	User def.	UD
30	GND	User def.	D31	User def.	UD
31	UD	User def.	GND	User def.	UD
32	GND	User def.	+5 V	User def.	UD

Backplanes, Technical Specifications



Automatic daisy chaining J1 and J1/J2

Via the use of connectors with integral mechanical switches, the contact is automatically opened when the daughterboard is inserted, and closed again when it is extracted.



Automatic daisy chaining VME64x

The second option for automatic daisy chaining is achieved here by an "or" logic integrated onto the backplane. If the daughterboard is extracted, the logic closes the daisy chain.

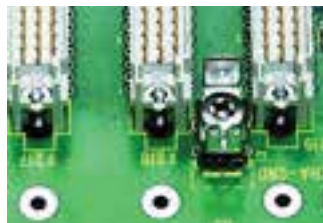

Chassis GND connection

An electrically conductive chassis GND surface is attached to the subracks in the mounting section of the backplane. This facilitates EMC-sealed mounting of the backplane on the sub-racks. With VME64x, RF linking of the subracks and system earth is achieved via capacitors (10nF, 200 V at each slot). Static charges are discharged via a resistor ($\geq 1 \text{ M}\Omega$). A combined connection component (screw M4 and FASTON 2.8 or 6.3 x 0.8 mm) is provided for connection of the enclosure earth.



Power connections

Infeed of the main operating voltage +5 V/+3.3 V and GND is provided via busbars with M6 screw terminal. The auxiliary operating voltages are supplied via double FASTONS with additional M4 screw thread. Optimum supply of the daughterboards and hence problem-free operation is ensured, thanks to the arrangement of the infeed modules on the backplane.

Utility connector

The special signals to the power pack and to external LEDs are routed on a separate connector on the backplanes.

A 7-pole, a 10-pole or a 14-pole connector with 2.54 mm spacing is provided, depending on the backplane type.

Pin assignment, 10/14 pins

GND	1	2	GND sense (5 V)
+5 V	3	4	+5 V Sense
ACFAIL-	5	6	ACFAIL-
SYSFAIL-	7	8	SYSFAIL-
SYSRESET-	9	10	SYSRESET-
+3,3 V	11	12	+3.3 V Sense
GND	13	14	GND sense (3.3 V)

J1, J1/J2: 10 pins, VME64x: 14 pins

Geographical address pin assignments (VME64x)

Slot no.	GAP Pin J1-D9	GA4 Pin J1-D17	GA3 Pin J1-D15	GA2 Pin J1-D13	GA1 Pin J1-D11	GA0 Pin J1-D10
1	Open	Open	Open	Open	Open	GND
2	Open	Open	Open	Open	GND	Open
3	GND	Open	Open	Open	GND	GND
4	Open	Open	Open	GND	Open	Open
5	GND	Open	Open	GND	Open	GND
6	GND	Open	Open	GND	GND	Open
7	Open	Open	Open	GND	GND	GND
8	Open	Open	GND	Open	Open	Open
9	GND	Open	GND	Open	Open	GND
10	GND	Open	GND	Open	GND	Open
11	Open	Open	GND	Open	GND	GND
12	GND	Open	GND	GND	Open	Open
13	Open	Open	GND	GND	Open	GND
14	Open	Open	GND	GND	GND	Open
15	GND	Open	GND	GND	GND	GND
16	Open	GND	Open	Open	Open	Open
17	GND	GND	Open	Open	Open	GND
18	GND	GND	Open	Open	GND	Open
19	Open	GND	Open	Open	GND	GND
20	GND	GND	Open	GND	Open	Open
21	Open	GND	Open	GND	Open	GND

Pin assignments J0

Pin no.	ROW Z	ROW A	ROW B	ROW C	ROW D	ROW E	ROW F
1 – 19	GND	User Defined	User Defined	User Defined	User Defined	User Defined	GND

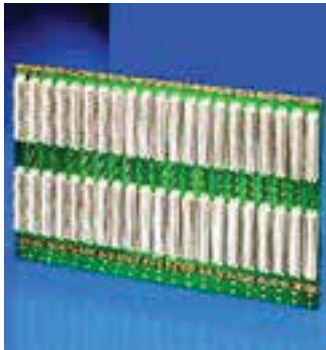
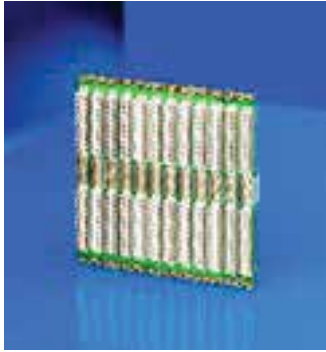

Backplanes VME64x

Technical specifications:

Number of layers	10
Layer structure	Optimised for optimum RF performance. Outer layers designed as shielding surface.
PCB thickness	4.5 mm ± 10 %
Ohmic resistance of the signal tracks	< 1 Ohm
Surge impedance Z of the signal tracks	55 Ohm
Basic power consumption, terminated at both ends	Active: < 200 mA, Passive: < 2 A
Power supply: – Busbar with M6 screw terminal – M4 screw terminal and FASTON 6.3 x 0.8 mm – < 5 slots	+5 V, +3.3 V and 0 V ±12 V, +5 V STBY, ±V1, ±V2 and case FASTON 6.3 x 0.8 mm
Current carrying capacity of busbar	max. 200 A
Current carrying capacity of a combined double flat-pin connector/screw terminal	25 A
Current carrying capacity of a FASTON flat connector	10 A
Current carrying capacity of the assembly per slot	+3.3 V 12.5 A +5 V 9.0 A +12 V 1.5 A –12 V 1.5 A +5 V STDBY 1.5 A +48 V (38 – 75 V) 3.0 A
Termination ON-/IN-board	6 U: active, 6.5 U: active (may be switched to passive)
Installation height	6 U/6.5 U
Distance between slots	4 HP
Connectors	Press-fit technique quality class 2, 400 connection cycles 160 pins compatible with C96 P0 spacing 2 mm, 95/133 pins
Operating temperature range	Active termination 0° ... +70°C Passive termination –40° ... +85°C
Relative humidity	90 %, non-condensing

VME64x 6U

Slots	Dimensions		Model No. RP	
	Height mm	Width mm	without P0 connector	with P0 connector
2	261.7	39.5	9912.423	9912.410
3	261.7	59.5	9912.424	9912.411
4	261.7	80	9912.425	9912.362
5	261.7	100	3687.608	3687.609
6	261.7	120.5	9912.426	9912.412
7	261.7	141	3687.610	3687.611
8	261.7	161.5	9912.427	9912.413
9	261.7	181.5	9904.930	9904.932
10	261.7	202	9904.931	9904.933
11	261.7	222.5	9912.428	9912.414

Slots	Dimensions		Model No. RP	
	Height mm	Width mm	without P0 connector	with P0 connector
12	261.7	242.5	3686.634	3686.473
13	261.7	263	9912.429	9912.415
14	261.7	283	9912.430	9912.416
15	261.7	303.5	9912.431	9912.417
16	261.7	324	9912.432	9912.418
17	261.7	344	9912.433	9912.419
18	261.7	364.5	9912.434	9912.420
19	261.7	385	9912.435	9912.421
20	261.7	405	9912.436	9912.422
21	261.7	425.5	3686.635	3686.474

VME64x 6.5U

Slots	Dimensions		Model No. RP	
	Height mm	Width mm	without P0 connector	with P0 connector
5	283.7	100	9910.012	9910.007
7	283.7	141	9910.013	9910.008
9	283.7	181.5	9910.014	9910.009
10	283.7	202	9904.928	9904.929
12	283.7	242.5	9910.015	9910.010
21	283.7	425.5	9910.016	9910.011

Material:
Fibreglass epoxy to IEC 60 249 (type FR4)

Supply includes:
Backplane, fully populated.

+ **Accessories:**

For backplane mounting:
Conductive strips, see page 122
Insulating strips, see page 123

Backplanes VME



Backplanes VME J1/J2

Monolithic

Technical specifications:

Number of layers	6
Layer structure	Optimised for optimum RF performance. Outer layers designed as shielding surface.
PCB thickness	3.2 mm \pm 10 %
Ohmic resistance of the signal tracks	< 1 Ohm
Surge impedance Z of the signal tracks	60 Ohm
Basic power consumption, terminated at both ends	Active: < 200 mA Passive: < 1.5 A
Power supply: – Busbar with screw terminal M6 – Screw terminal M4 and FASTON 6.3 x 0.8 mm – < 5 slots	+5 V and 0 V \pm 12 V, +5 V STBY and case FASTON 6.3 x 0.8 mm
Current carrying capacity of busbar	max. 200 A
Current carrying capacity of a combined double flat-pin connector/screw terminal	25 A
Current carrying capacity of a FASTON flat connector	10 A
Current carrying capacity of the assembly per slot	+5 V 9.0 A +12 V 1.5 A –12 V 1.5 A +5 V STDBY 1.5 A
Termination ON-/IN-board	active (may be switched to passive)
Installation height	6U
Distance between slots	4 HP
Connectors	Press-fit technique quality class 2, 400 connection cycles C96
Operating temperature range	Active termination 0° . . . +70°C Passive termination –40° . . . +85°C
Relative humidity	90 %, non-condensing

Slots	Dimensions		Model No. RP
	Height mm	Width mm	
2	261.7	39.5	3686.495
3	261.7	59.5	3686.496
4	261.7	80	3686.497
5	261.7	100	3686.498
6	261.7	120.5	3686.499
7	261.7	141	3686.500
8	261.7	161.5	3686.501
9	261.7	181.5	3686.502
10	261.7	202	3686.503
11	261.7	222.5	3686.504
12	261.7	242.5	3686.505
13	261.7	263	3686.506
14	261.7	283	3686.507
15	261.7	303.5	3686.508
16	261.7	324	3686.509
17	261.7	344	3686.510
18	261.7	364.5	3686.511
19	261.7	385	3686.512
20	261.7	405	3686.513
21	261.7	425.5	3686.514

Material:

Fibreglass epoxy to IEC 60 249 (type FR4)

Supply includes:

Backplane, fully populated.

**Accessories:**

For backplane mounting:
Conductive strips, see page 122
Insulating strips, see page 123



VME J1 system bus

Technical specifications:

	VME J1	VME J2
Number of layers	6	2
Layer structure	Optimised for optimum RF performance. Outer layers designed as shielding surface.	
PCB thickness	3.2 mm ±10 %	3.2 mm ±10 %
Ohmic resistance of the signal tracks	< 1 Ohm	< 1 Ohm
Surge impedance Z of the signal tracks	60 Ohm	60 Ohm
Basic power consumption, terminated at both ends	Active: < 150 mA Passive: < 1.2 A	Passive: < 0.6 A
Power supply: – M4 screw terminal and FASTON 6.3 x 0.8 mm – < 5 slots	+5 V, 0 V, ±12 V, ±5 V STBY and case FASTON 6.3 x 0.8 mm	x FASTON 6.3 x 0.8 mm
Current carrying capacity of a combined double flat-pin connector/screw terminal	25 A	25 A
Current carrying capacity of a FASTON flat connector	10 A	10 A
Current carrying capacity of the assembly per slot	+5 V 4.5 A +12 V 1.5 A –12 V 1.5 A +5 V STDBY 1.5 A	+5 V 4.5 A
Termination ON-/IN-board	active (may be switched to passive)	active (may be switched to passive)
Installation height	3 U	3 U
Distance between slots	4 HP	4 HP
Connectors	Press-fit technique quality class 2, 400 connection cycles C96	Press-fit technique quality class 2, 400 connection cycles C96
Operating temperature range	Active termination 0° ... +70°C Passive termination –40° ... +85°C	Passive termination –40° ... +85°C
Relative humidity	90 %, non-condensing	90 %, non-condensing

Slots	Dimensions		Model No. RP
	Height mm	Width mm	
3	128.4	59.5	3686.555
4	128.4	80	3686.556
5	128.4	100	3686.557
6	128.4	120.5	3686.558
7	128.4	141	3686.559
8	128.4	161.5	3686.560
9	128.4	181.5	3686.561
10	128.4	202	3686.562

Slots	Dimensions		Model No. RP
	Height mm	Width mm	
12	128.4	242.5	3686.563
13	128.4	263	3686.564
14	128.4	283	3686.565
15	128.4	303.5	3686.566
18	128.4	364.5	3686.567
20	128.4	405	3686.568
21	128.4	425.5	3686.569

Material:
Fibreglass epoxy to IEC 60 249 (type FR4)

Supply includes:
Backplane, fully populated.

+ **Accessories:**

For backplane mounting:
Conductive strips, see page 122
Insulating strips, see page 123



VME J2 expansion bus

Material:
Fibreglass epoxy to IEC 60 249 (type FR4)

Supply includes:
Backplane, fully populated.

+ **Accessories:**

For backplane mounting:
Conductive strips, see page 122
Insulating strips, see page 123

Slots	Dimensions		Model No. RP
	Height mm	Width mm	
3	128.4	59.5	3686.585¹⁾
4	128.4	80	3686.586¹⁾
5	128.4	100	3686.587¹⁾
6	128.4	120.5	3686.588¹⁾
7	128.4	141	3686.589¹⁾
8	128.4	161.5	3686.590¹⁾
9	128.4	181.5	3686.591¹⁾
10	128.4	202	3686.592¹⁾

Slots	Dimensions		Model No. RP
	Height mm	Width mm	
12	128.4	242.5	3686.593¹⁾
13	128.4	263	3686.594¹⁾
14	128.4	283	3686.595¹⁾
15	128.4	303.5	3686.596¹⁾
18	128.4	364.5	3686.597¹⁾
20	128.4	405	3686.598¹⁾
21	128.4	425.5	3686.599¹⁾

¹⁾ Delivery times available on request.

¹⁾ Delivery times available on request.