

# Front Panel Service



Front panels are structural elements which need to be designed individually depending on the application. Particularly for small quantities (1 – 50 units), this entails a high time input in terms of development and production.

With this in mind, Pixus offers its customers a service which covers the entire machining process, right through to assembly.

Services in detail:

- Machining: drilling, milling, thread tapping, countersinking
- Surface finishing: labelling, surface printing
- Assembly: EMC gaskets, handles, PCB holders.

# Front Panels, Handles



## Flat front panels with type I or II extractor handle

Complete modular systems

### Material:

Front panel: 2.5 mm aluminium, anodised

Handle: Plastic, black

### Supply includes:

- 1 front panel,
- 2 handles (1 with 3U),
- 1 set of assembly parts,
- 1 PCB holder (for 3U).

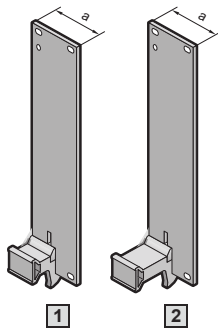

U (HE)	HP (TE)	a mm	Model No. RP	
			Type I	Type II
3	4	20.0	3684.330	3684.358
3	5	25.1	3684.331	3684.359
3	6	30.2	3684.332	3684.360
3	7	35.3	3684.333	3684.361
3	8	40.3	3684.334	3684.362
3	10	50.5	3684.335	3684.363
3	12	60.7	3684.336	3684.364
6	4	20.0	3684.337	3684.365
6	5	25.1	3684.338	3684.366
6	6	30.2	3684.339	3684.367
6	7	35.3	3684.340	3684.368
6	8	40.3	3684.341	3684.369
6	10	50.5	3684.342	3684.370
6	12	60.7	3684.343	3684.371
9	4	20.0	—	3684.372
9	8	40.3	—	3684.373

Available with optional metal screw collars.

## Front panels with type I, II or IV, IVs, VII extractor handles

3U

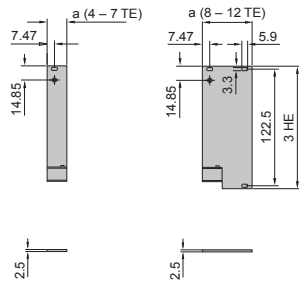

6U

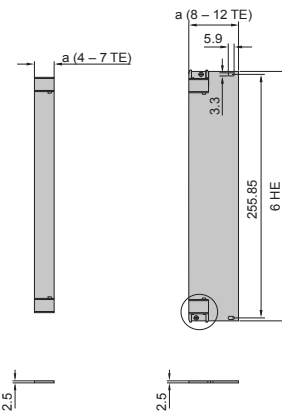

9U

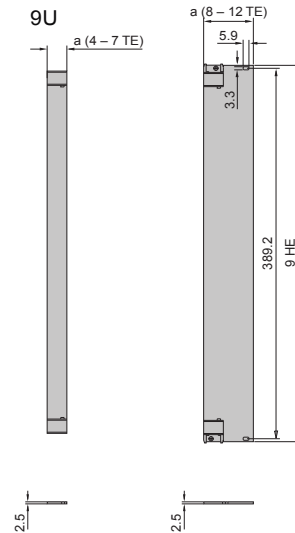

## Extractor handles

Type I



Type II

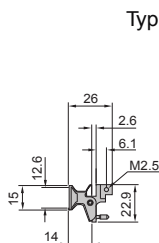

Type IV/IVs

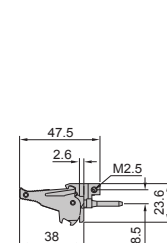
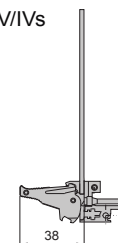
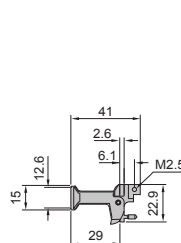

Front Panels, Handles

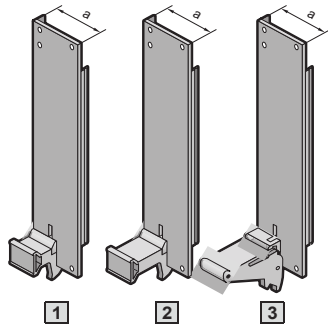

**U-channel front panels with type I, II extractor handle or type IV injector handle**

Complete modular systems

**Material:**

Front panel: Extruded aluminium section, clear-chromated  
Handle: Plastic, black

**Supply includes:**

- 1 front panel,
- 2 handles (1 with 3U),
- 1 EMC gasket, vertical, version 1,
- 1 set of assembly parts,
- 1 PCB holder (for 3U).



U	HP	a mm	Model No. RP		
			1 Type I	2 Type II	3 Type IV <sup>1)</sup>
3	4	20.0	3684.344	3684.374	3684.413
3	5	25.1	3684.345	3684.375	3684.414
3	6	30.2	3684.346	3684.376	3684.415
3	7	35.3	3684.347	3684.377	3684.416
3	8	40.3	3684.348	3684.378	3684.417
3	10	50.5	3684.349	3684.379	3684.418
3	12	60.7	3684.350	3684.380	3684.419
6	4	20.0	3684.351	3684.381	3684.420
6	5	25.1	3684.352	3684.382	3684.421
6	6	30.2	3684.353	3684.383	3684.422
6	7	35.3	3684.354	3684.384	3684.423
6	8	40.3	3684.355	3684.385	3684.424
6	10	50.5	3684.356	3684.386	3684.425
6	12	60.7	3684.357	3684.387	3684.426
9	4	20.0	-	3684.388	3684.427
9	5	25.1	-	-	3684.428
9	6	30.2	-	-	3684.429
9	7	35.3	-	-	3684.430
9	8	40.3	-	3684.389	3684.431
9	10	50.5	-	-	3684.432
9	12	60.7	-	-	3684.433

<sup>1)</sup> Can only be inserted in conjunction with front horizontal rails, with 10 mm roof (B)

Available with optional metal screw collars.

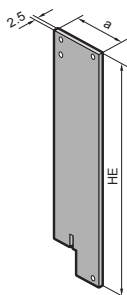
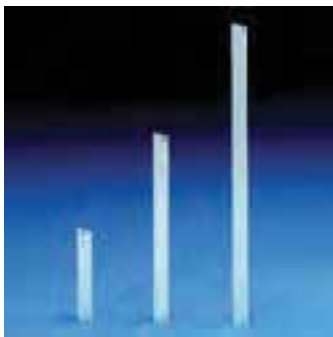

**Flat front panels for type I, II, IV, IVs or VII handles**

**Material:**

2.5 mm aluminium, anodised

HP	a mm	Model No. RP		
		3 U (HE)	6 U (HE)	9 U (HE)
4	20.0	3685.500	3685.508	3685.516
5	25.1	3685.501	3685.509	3685.517
6	30.2	3685.502	3685.510	3685.518
7	35.3	3685.503	3685.511	3685.519
8	40.3	3685.504	3685.512	3685.520
10	50.5	3685.505	3685.513	3685.521
12	60.7	3685.506	3685.514	3685.522

Available with optional metal screw collars.



**Also required:**

From front panel widths of 4 HP (at 3U) and 7 HP (at 6U):

Collar screws and plastic collars, packs of 100 sets, Model No. RP 3658.160, see page 159.

For 3U front panels: PCB holder set, see page 150.

# OpenVPX Front Panels, EMC

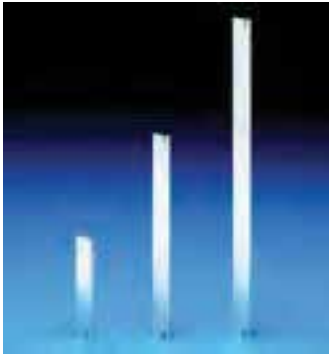

## U-channel front panels for type IV and IVs handles

**Material:**  
2.5 mm extruded aluminium section, clear-chromated.



HP	a mm	Model No. RP	
		3U H = 128.7	6U H = 262.05
4	20	PF30039	PF60039
5	25.1	PF30040	PF60040
8	40.3	PF30041	PF60041
10	50.5	PF30042	PF60042

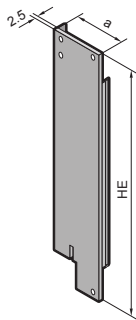

**Part Number Configurator** PF U ID H V S L F G C

- PF = Panel Filters
- U = 3U or 6U
- ID = Part No. Identifier
- H = Handle
  - 0 = None
  - 4 = Type IV
  - 5 = Type IVs
- V = Colour
  - B = Black
  - G = Grey
- S = Micro-Switch w cable
  - 0 = None
  - 1 = One
  - 2 = Two

\* Only applicable to 6U
- L = ID Label
  - 0 = None
  - 1 = Yes
- F = Fastening
  - 0 = Screw(s) only
  - 1 = Screw(s) + Plastic Collar(s)
  - 2 = Screw(s) + Metal Collar(s)
- G = Gasket
  - 1 = Segmented
  - 2 = Non-segmented
- C = Coating
  - Blank = Chromate
  - 1 = Anodized Front, Chromate remainder

### Front panels for type handles

#### 3U

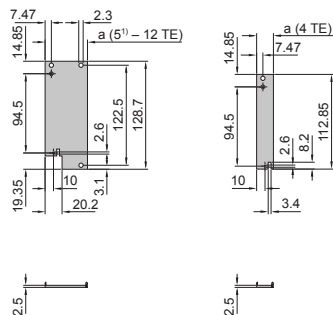

#### 6U

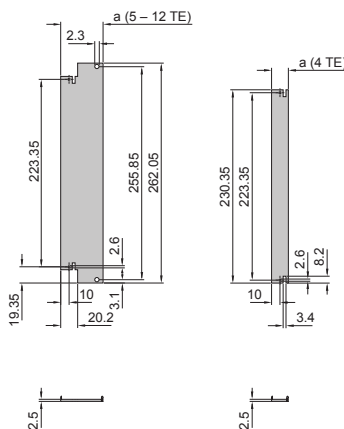

#### 6U (5HP)

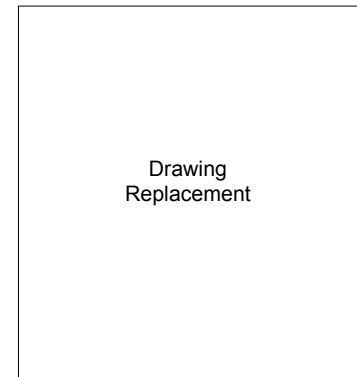

PCB Holder for 3U Panels

- 1) 2.3 mm drilled hole not contained in versions 4 - 5 HP.
- 2) Only Type IVs version is recommended for 6U VPX panels.
- 3) 3U sets include 1 PCB holder



## Injector/Extractor Handles



### Extractor handle type I and type II

- Suitable for at front panels/ U-channel front panels
- With removal function
- May be used in combination with horizontal rails with 10 mm extension.

**Supply includes:**  
Assembly parts.

**Note:**

With 3 U, only one extractor handle is required.

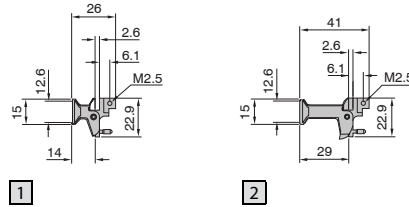
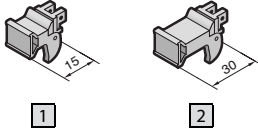

**1** Type I extractor handle, 15 mm

Colour	Packs of	Model No. RP
Grey	1	3685.587
Black	1	3685.589

**2** Type II extractor handle, 30 mm

Colour	Packs of	Model No. RP
Grey	1	3685.588
Black	1	3685.590

**+** Accessories:

Identification strips for extractor handles, see page 143.



### Injector/extractor handle type IV

**Handles with micro-switch**

For inserting and removing connectors with a large number of pins.

- Insertion/removal function
- Integral microswitch for “live insertion” applications
- Self-activation of the micro-switch during insertion/removal
- ESD pin to dissipate static charges before contacting the connectors and for precise positioning of the board type plug-in unit
- Codeable
- Integral PCB attachment
- Self-locking
- Bayable.

**Handle without micro-switch**

Description see above. Micro-switch, may be retrofitted.

**Supply includes:**

1 handle without or with micro-switch, assembly parts.

**Note:**

- Insertion only when used with front horizontal rails, with 10 mm extension (B, B1, B2), see pages 117, 118.
- With 3U front panels, only one extractor handle is required.

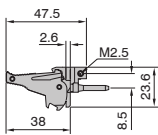
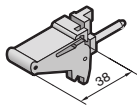

**Handles with micro-switch**

Colour	Installation	Packs of	Model No. RP
Grey	top	1	<b>3686.905</b>
Grey	bottom	1	<b>3686.904</b>
Black	top	1	<b>3686.907</b>
Black	bottom	1	<b>3686.906</b>

**Handle without micro-switch**

Colour	Installation	Packs of	Model No. RP
Grey	top	1	<b>3686.901</b>
Grey	bottom	1	<b>3686.900</b>
Black	top	1	<b>3686.903</b>
Black	bottom	1	<b>3686.902</b>

**+** Accessories:

Keys, see page 132.

Keyable guide rails, see page 129.

Micro-switches, see page 145.

Connector pin for baying, see page 143.



### Injector/extractor handle type IV

**8 HP, bayed**

Suitable for 4 HP front panels that must be connected to each other mechanically.

**Supply includes:**

2 bayed handles, fully assembled.

Colour	Installation	Packs of	Model No. RP
Black	bottom	1	<b>3686.908</b>
Black	top	1	<b>3686.909</b>

**+** Accessories:

Connector pin for baying, see page 143.

## OpenVPX Front Panel, With Type IVs Injector/Extractor Handle

**Material:**

Front Panel: 2.5mm aluminum, extruded, clear chromated

Handle: Plastic / Metal

U = 1.75", TE/HP = 0.2"

**Supply Includes:**

1 front panel, 2 Type IVs handle (1 Type IVs handle for 3U)

1 vertical EMC gasket, Type II

1 set of assembly parts

1 PCB holder (for 3U)

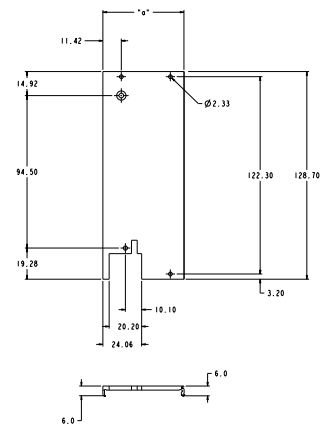
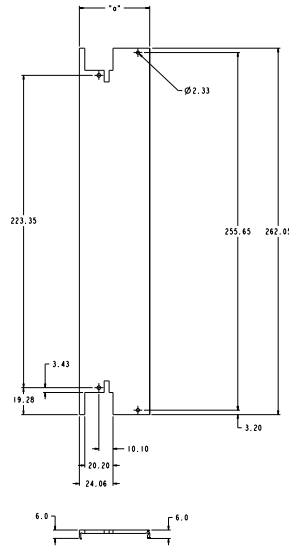

U	TE (HP)	H mm	a mm	b mm	Part Numbers
3	4	128.7	20.0	7.47	9922504
3	5	128.7	25.1	7.47	9922505
6	4	262.05	20.0	11.35	9922507
6	5	262.05	25.1	11.35	9922508

8HP, 10HP, and 12HP also available standard, consult Sales



**Identification strips**

for type I, II extractor handle and type IV injector/extractor handle  
Width 4 HP

Packs of	Model No. RP
100	3684.328



**Injector/extractor handle type IVs with push-button**

For inserting and removing connectors with a large number of pins. A metal insert ensures reliable functioning, even at forces of up to 815 N.

- Insertion/removal function
- Push-button for locking and unlocking the board type plug-in unit (cannot be extracted in the locked position)
- Optionally with 1/2 HP offset PCB attachment, e.g. for component mounting on both sides
- Optional integral micro-switch for "live insertion" applications
- ESD pin to dissipate static charges before contacting the connectors and for precise positioning of the board type plug-in unit
- Codeable
- Integral PCB attachment
- Bayable.

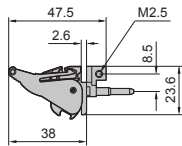

**Material:**  
Plastic/metal

**Supply includes:**  
Assembly parts.

- Note:**
- Insertion only when used with front horizontal rails, with 10 mm extension (B),
  - With 3 U front panels, only one extractor handle is required.

**Handles without offset**

Installation	Packs of	Model No. RP
top	1	3688.770
bottom	1	3688.771

**Handles with 1/2 HP offset**

Installation	Packs of	Model No. RP
top	1	3688.772
bottom	1	3688.773

**Accessories:**

- Keys, see page 132.
- Keyable guide rails, see page 129.
- Keyable guide rails with 1/2 HP offset, see page 129.
- Micro-switches, see page 145.
- Connector pin for buying, see page 143.



**Connection pin for injector/extractor handles, types IV, IVs and VII**

The connection pin can be used to connect injector/extractor handles, types IV, IVs and VII.

**Material:**  
Steel

Packs of	Model No. RP
20	3685.319

## Injector/Extractor Handles

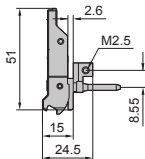

### Injector/extractor handle type VII

#### Plastic (telecom)

For inserting and removing connectors with a large number of pins. This handle was specifically designed for use in telecom applications.

- Insertion/removal function
- Optionally with 1/2 HP offset PCB attachment, e.g. for component mounting on both sides
- Minimum front space requirements, due to fold-up handle
- Codeable
- Optional integral micro-switch for "live insertion" applications
- ESD pin to dissipate static charges prior to making contact with the connectors and for precise positioning of the board type plug-in unit
- Large labelling area on the front.

**Material:**  
Plastic

**Supply includes:**  
Assembly parts.

**Note:**  
Insertion only when used with front horizontal rails, with 10 mm extension (B),

#### Handles without offset

Installation	Packs of	Model No. RP
top	1	3688.784
bottom	1	3688.785

#### Handles with 1/2 HP offset

Installation	Packs of	Model No. RP
top	1	3688.780
bottom	1	3688.781



#### Accessories:

Keys, see page 132.

Keyable guide rails, see page 129.

Keyable guide rails with 1/2 HP offset, see page 129.

Micro-switches, see page 145.

Connector pin for buying, see page 143.

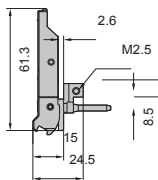

### Injector/extractor handle type VII

#### Metal (telecom)

For inserting and removing connectors with a large number of pins (up to 815 N). This handle was specifically designed for use in telecom applications.

- Insertion/removal function
- Optionally with 1/2 HP offset PCB attachment, e.g. for component mounting on both sides
- Minimum front space requirements, due to fold-up handle
- Codeable
- Optional integral micro-switch for "live insertion" applications
- ESD pin to dissipate static charges prior to making contact with the connectors and for precise positioning of the board type plug-in unit
- Metal design for use in aggressive atmospheres.

**Material:**  
Die-cast zinc

**Supply includes:**  
Assembly parts.

**Note:**  
Insertion only when used with front horizontal rails, with 10 mm extension (B),

#### Handles without offset

Installation	Packs of	Model No. RP
top	1	3688.790
bottom	1	3688.791

#### Handles with 1/2 HP offset

Installation	Packs of	Model No. RP
top	1	3688.786
bottom	1	3688.787



#### Accessories:

Keys, see page 132.

Keyable guide rails, see page 129.

Keyable guide rails with 1/2 HP offset, see page 129.

Micro-switches, see page 145.

Connector pin for buying, see page 143.



### Micro-switch

For "live insertion" applications. Installation in injector/extractor handles, types IV, IVs and VII. May also be retrofitted.

**Technical specifications:**  
Switching load: 50 mA 30 V DC  
Service life/switching cycles:  
At nominal load: 30,000  
mechanical: 50,000

Packs of	Model No. RP
10	3684.410



#### Also required:

Micro-switch mounting clip, see page 145.



**Micro-switch**

**with cable and connector**

For "live insertion" applications. Installation in injector/extractor handles, types IV, IVs and VII.

**Supply includes:**

Micro-switch, connector type Molex 51021-0300, mounting clips, 3 cables, 25 mm x #32 AWG, fully assembled.

- 1 Lever not depressed
- 2 Lever hinge
- 3 Lever contact point

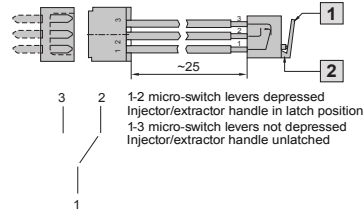

Packs of	<b>Model No. RP</b>
1 set	<b>3686.536</b>

**!** Also required:

Micro-switch mounting clip, see page 145.

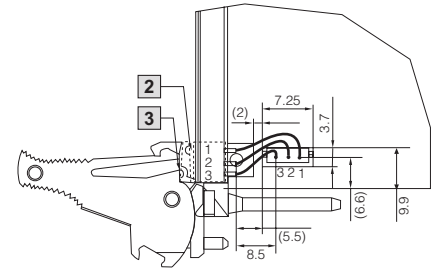

**Micro-switch mounting clip**

For mounting micro-switches in handles.

Packs of	<b>Model No. RP</b>
10	<b>3684.411</b>



**Plastic covers**

**for PCBs**

For mechanical protection of the component side and of the EMC gaskets. Attachment holes as per cPCI or VME-specifications. Optionally available as perforated or solid version.

**Material:**

0.3 mm plastic, anti-static  
Maximum temperature up to 65°C

<sup>1)</sup> 0.5 mm plastic, transparent, anti-static  
UL 94-V0, maximum temperature up to 65°C

<sup>2)</sup> 0.5 mm plastic, black, anti-static UL 94-V0,  
maximum temperature up to 120°C

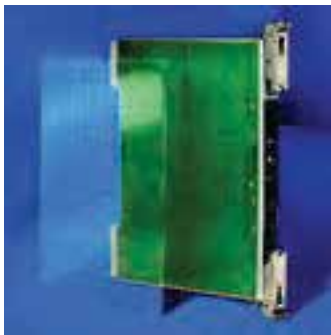

For PCBs	Packs of	Model No. RP			
		for cPCI		for VME	
		perforated <sup>1)</sup>	solid <sup>1)</sup>	solid	solid
3U x 160 mm	1	<b>3687.932</b>	<b>3686.572</b>	<b>3685.966</b>	<b>3685.626</b>
	5	—	—	—	<b>3685.279</b>
3U x 220 mm	1	—	—	—	<b>3685.805</b>
	5	—	—	—	<b>3685.266</b>
6U x 80 mm	1	<b>3687.933</b>	<b>3686.573</b>	<b>3686.037</b>	<b>3686.146</b>
6U x 160 mm	1	<b>3687.934</b>	<b>3686.574</b>	<b>3685.967</b>	<b>3685.627</b>
	1	<b>9905.574<sup>2)</sup></b>	<b>9905.990<sup>2)</sup></b>	—	—
	5	—	—	—	<b>3685.280</b>
6U x 220 mm	1	—	—	—	<b>3685.824</b>
	5	—	—	—	<b>3685.000</b>

**!** Also required:

Required for mounting the perforated cPCI covers:

Mounting clips

Packs of	<b>Model No. RP</b>
100	<b>3687.955</b>

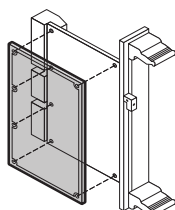

## Front Panels, Handles

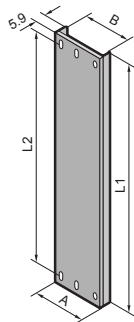

### Front panels for type III extractor handle

**Material:**  
1.0 mm extruded aluminium section

**Surface finish:**  
Untreated

HP	A mm	W (B) mm	C1 mm	C2 mm	Model No. RP		
					3U	6U	9U
3	15.20	12.20	-	-	<b>3685.548</b>	<b>3685.555</b>	-
4	20.22	17.20	-	-	<b>3685.549</b>	<b>3685.556</b>	<b>3685.562</b>
5	25.28	22.28	-	22.68	<b>3685.550</b>	<b>3685.557</b>	<b>3685.563</b>
6	30.36	27.36	-	25.22	<b>3685.551</b>	<b>3685.558</b>	<b>3685.564</b>
8	40.52	37.52	-	30.30	<b>3685.552</b>	<b>3685.559</b>	<b>3685.566</b>
10	50.68	47.68	40.46	25.22	<b>3685.553</b>	<b>3685.560</b>	<b>3685.567</b>
12	60.84	57.84	50.62	30.30	<b>3685.554</b>	<b>3685.561</b>	<b>3685.568</b>
L1 mm					97.00	230.35	363.70
L2 mm					90.00	223.35	356.70

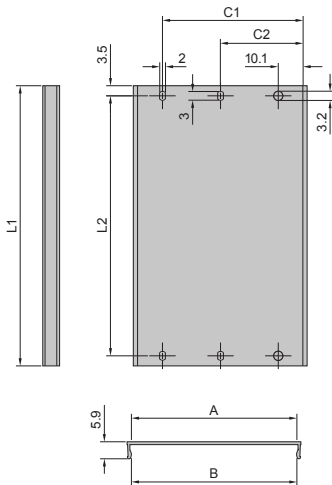

### Type III handle, extractor

**Material:**  
Fibreglass-reinforced polycarbonate  
Base section nickel-plated ABS

**Colour:**  
Grey

HP	Packs of	Model No. RP
3	1	<b>3685.591</b>
4	1	<b>3685.592</b>

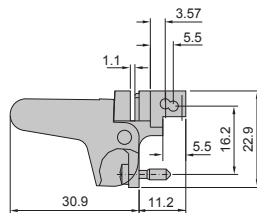
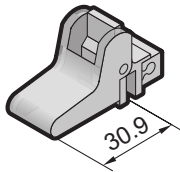

### Covers for panel and spaces

**Material:**  
Fibreglass-reinforced polycarbonate

HP	Width mm	Packs of	Model No. RP
1	5	1	<b>3687.529</b>
2	10.08	1	<b>3687.530</b>
4	20.24	1	<b>3687.531</b>



**Universal holder**

for front panel support

**Material:**  
Nickel-plated plastic

HP	Packs of	Model No. RP
4	1	3687.545



**Flat front panels**

with type V handle and PCB holder  
Complete modular systems

**Material:**  
Front panel: 2.5 mm aluminium, natural anodised  
Handle: aluminium, natural anodised  
PCB holder: polycarbonate

**Supply includes:**  
1 front panel,  
1 handle (2 with 6 U),  
1 PCB holder (2 with 6 U),  
assembly parts.

HP	a mm	W (B) mm	Model No. RP	
			3U H = 128.7	6U H = 262.05
3	14.9	-	3652.000	3652.200
4	20.0	-	3652.010	3652.210
5	25.1	-	3652.020	3652.220
6	30.1	-	3652.030	3652.230
7	35.2	-	3652.040	3652.240
8	40.3	-	3652.050	3652.250
10	50.5	35.6	3652.060	3652.260
12	60.6	45.7	3652.070	3652.270
14	70.8	55.9	3652.080	-

Available with optional metal screw collars.

**+ Accessories:**

Identification strips for handles,  
see page 149.

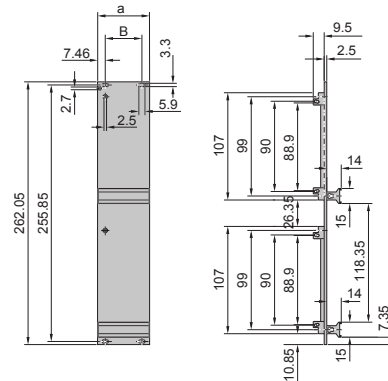
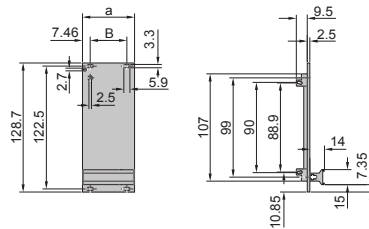
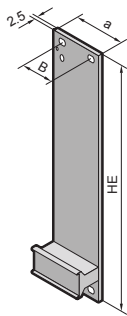

## Front Panels, Handles

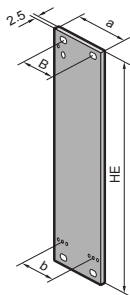

### Flat front panels for type V and VI handle

**Material:**  
2.5 mm aluminium, anodised

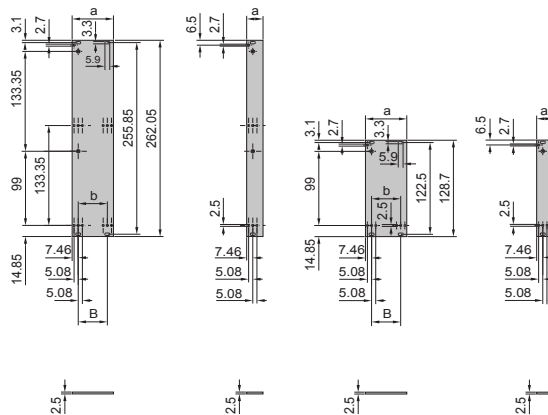

HP	a mm	W (B) mm	b mm	Packs of	Model No. RP	
					3U	6U
3	14.9	–	–	1	3685.569	3685.578
4	20.0	–	–	1	3685.570	3685.579
5	25.1	–	–	1	3685.571	3685.580
6	30.2	–	15.2	1	3685.572	3685.581
7	35.2	–	20.3	1	3685.573	3685.582
8	40.3	–	25.4	1	3685.574	3685.583
10	50.5	35.6	35.6	1	3685.575	3685.584
12	60.6	45.7	45.7	1	3685.576	3685.585
14	70.8	55.9	55.9	1	3685.577	3685.586

Available with optional metal screw collars.

**! Also required:**

Collar screws and plastic collars, packs of 100 sets, Model No. RP 3658.160, see page 159.

**+ Accessories:**

Handles type V, see page 149.  
Handles type VI, see page 150.

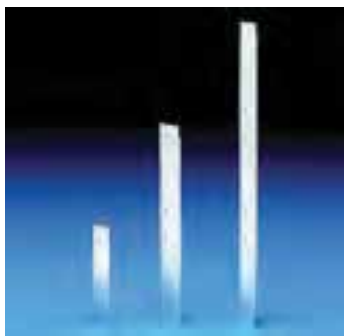

### U-channel front panels for type V and VII handle

**Material:**  
2.5 mm aluminium, clear-chromated

**Supply includes:**  
1 vertical EMC gasket, version 1.



HP	a mm	W (B) mm	Packs of	Model No. RP	
				3U	6U
4	20.0	–	1	3687.655	3687.660
6	30.2	–	1	3687.656	3687.661
8	40.3	–	1	3687.657	3687.662
10	50.5	35.6	1	3687.658	3687.663
12	60.6	45.7	1	3687.659	3687.664

**! Also required:**

Slotted centering screws, packs of 100, Model No. RP 3687.050, Posidrive centering screws, see page 160.  
packs of 100, Model No. RP 3687.051, see page 160.

**+ Accessories:**

Handles type V, see page 149.  
Handles type VI, see page 150.



Front Panels, Handles



**Type V handle**

**Plastic**

**Material:**  
Plastic

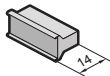

HP	Colour	Packs of	Model No. RP
3	Grey	1	3685.490
4	Grey	1	3685.491
8	Grey	1	3685.492
12	Grey	1	3685.493
20	Grey	1	3685.494
3	Black	1	3685.495
4	Black	1	3685.496
8	Black	1	3685.497
12	Black	1	3685.498
20	Black	1	3685.499



**Also required:**

Mounting kit,  
packs of 1 set, Model No. RP 3687.519  
see page 159.

**Identification strips  
for type V handle, plastic  
self-adhesive**

HP	Packs of	Model No. RP
24	1	3687.693



**Type V handle**

**Aluminium**

**Material:**  
Aluminium, anodised.

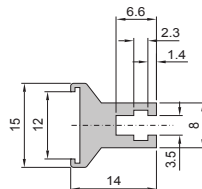
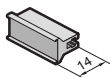

HP	Model No. RP	HP	Model No. RP
3	3685.595	12	3685.602
4	3685.596	14	3685.603
5	3685.597	21	3685.761
6	3685.598	28	3685.762
7	3685.599	42	3685.763
8	3685.600	1 m	3685.604
10	3685.601		



Custom lengths available.



**Also required:**

Mounting kit, see page 160.  
packs of 1 set, Model No. RP 3687.146,  
(from 6 HP 2 packs required), see page 160.

**Identification strips  
for type V handle, aluminium**

For individual labelling of the handles.

**Material:**  
0.5 mm aluminium, anodised

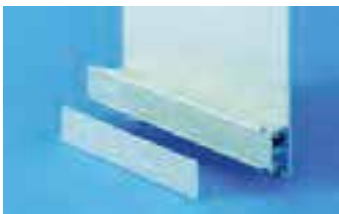

HP	Packs of	Model No. RP
3	1	3685.746
4	1	3685.747
5	1	3685.748
6	1	3685.749
7	1	3685.750
8	1	3685.751
10	1	3685.752
12	1	3685.753
14	1	3685.754
21	1	3685.755
28	1	3685.756
42	1	3685.757
1 m	1	3685.758
0.5 m	5	3606.300



Custom lengths available.

## Front Panels, Handles

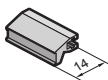

### Type VI handle

**Aluminium**

**Material:**  
Aluminium, anodised

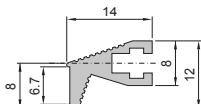

HP	Model No. RP	HP	Model No. RP
3	3685.605	12	<b>3685.612</b>
4	3685.606	14	<b>3685.613</b>
5	3685.607	21	<b>3685.614</b>
6	3685.608	28	<b>3685.615</b>
7	3685.609	42	<b>3685.616</b>
8	3685.610	84	<b>3685.617</b>
10	3685.611	1 m	<b>3685.618</b>

Custom lengths available.

**! Also required:**

Mounting kit  
packs of 1 set, Model No. RP 3687.146  
(from 6 HP 2 packs required),  
see page 160.



### PCB holder kit

**For attaching the PCB to front panels with handle types I, II, IV, IVs, VII.**

**Material:**  
Die-cast

**Note:**  
Only required at the top with 3U front panels.

Packs of	Model No. RP
10	<b>3685.198</b>

**! Also required:**

For securing PCBs to PCB holders:  
Pan-head screws  
packs of 100, Model No. RP 3654.320,  
see page 159.  
For attaching the front panel to the PCB holder:  
Oval head screw  
packs of 100, Model No. RP 3685.282,  
see page 160.



### PCB holder

**For front panels**  
For attaching PCBs to front panels  
(handle type V, VI).

**Material:**  
Noryl

**Supply includes:**  
Assembly parts.

Packs of	Model No. RP
10	<b>3606.330</b>

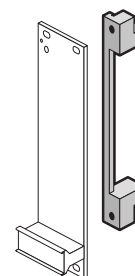



**Front panels  
as filler panel, flat**

**Material:**  
2.5 mm aluminium

Clear chromate  
Supply includes:  
Posidrive centering screws

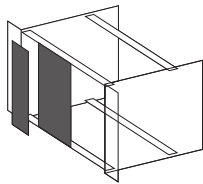
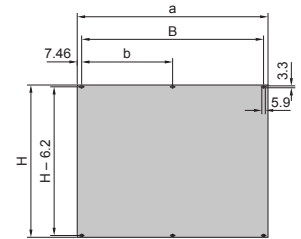

HP	a mm	W (B) mm	b mm	Model No. RP						
				1 U H = 39.8	2 U H = 84.25	3 U H = 128.7	4U H = 173.15	6U H = 262.05	7U H = 306.5	9U H = 395.4
2	9.8	-	-	-	-	3684.889	-	3684.911	-	3684.738
3	14.9	-	-	-	-	3684.890	-	3684.912	-	-
4	20.0	-	-	-	-	3684.891	-	3684.913	-	3684.739
5	25.1	-	-	-	-	3684.892	-	3684.914	-	-
6	30.1	-	-	-	-	3684.893	-	3684.915	-	-
7	35.2	-	-	-	-	3684.894	-	3684.916	-	-
8	40.3	-	-	-	-	3684.895	-	3684.917	-	3684.740
10	50.5	35.6	-	-	-	3684.896	-	3684.918	-	-
12	60.6	45.7	-	-	-	3684.897	-	3684.919	-	3684.741
14	70.8	55.9	-	-	-	3684.898	-	3684.920	-	-
20	101.3	86.4	-	-	-	3684.899	-	3684.921	-	-
21	106.4	91.4	-	-	3685.350	3684.900	-	3684.922	-	-
24	121.7	106.7	-	-	3685.429	-	-	-	-	-
27	136.8	121.9	-	-	-	3684.901	-	3684.923	-	-
28	141.9	127.0	-	-	-	3684.902	-	3684.924	-	-
40	202.9	188.0	-	-	-	3684.903	-	3684.976	-	3684.977
42	213.0	198.1	-	3684.885	3684.887	3684.904	3684.908	3684.925	3684.928	3684.742
60	304.5	289.6	-	-	-	3684.905	-	-	-	-
63	319.7	304.8	152.4	-	-	3684.906	3684.909	3684.926	3684.929	-
84	426.4	411.5	203.2	3684.886	3684.888	3684.907	3684.910	3684.927	3684.930	3684.743
85	431.5	431.5	203.2	-	-	3684.744	3684.745	3684.746	3684.747	3684.748

Other variants available upon request.

OpenVPX Front Filler Panels, Flat



**Front panels as filler panel, flat**

**Material:**  
2.5 mm aluminium

Clear chromate  
Supply includes:  
Posidrive centering screws

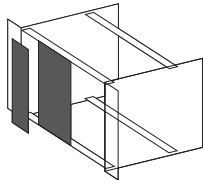
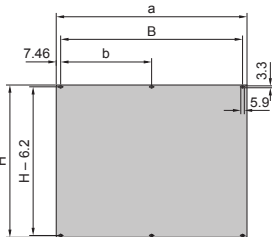

HP	a mm	W (B) mm	b mm	Model No. RP	
				3U H = 128.7	6U H = 262.05
4	20	--	--	PF30001	PF60001
5	25.1	--	--	PF30002	PF60002
9	45.4	--	--	PF30003	PF60003
10	50.5	35.6	--	PF30004	PF60004
15	75.9	61	--	PF30005	PF60005
20	101.3	86.4	--	PF30006	PF60006
24	121.7	106.7	--	PF30007	PF60007
25	126.7	111.8	--	PF30008	PF60008
29	147	132.1	--	PF30009	PF60009
30	152.1	137.2	--	PF30010	PF60010
35	177.5	162.6	--	PF30011	PF60011
40	202.9	188	94	PF30012	PF60012
45	228.3	213.4	106.6	PF30013	PF60013
50	253.7	238.8	119.4	PF30014	PF60014
55	279.1	264.2	132	PF30015	PF60015
60	304.5	289.6	144.8	PF30016	PF60016
65	329.9	315	157.6	PF30017	PF60017
70	355.3	340.4	170.2	PF30018	PF60018
75	380.7	365.8	183	PF30019	PF60019

Other variants available upon request.

**Part Number Configurator**

PF = Panel Fillers \_\_\_\_\_ PF U ID F C

U = 3U or 6U \_\_\_\_\_

ID = Part No. Identifier \_\_\_\_\_

F = Fastening 0 = Screw(s) only \_\_\_\_\_

                  1 = Screw(s) + Plastic Collar(s) \_\_\_\_\_

                  2 = Screw(s) + Metal Collar(s) \_\_\_\_\_

C = Coating Blank - Chromate \_\_\_\_\_

                  1 = Anodized Front, Chromate remainder \_\_\_\_\_

# OpenVPX Front Panels, EMC



## Front panels as filler panels, U-shaped

**Material:**  
2.5 mm extruded aluminium section, clear-chromated

**Supply includes:**  
1 front panel, one-piece (with 2 – 14 HP version) or three-piece (with > 14 HP version),  
1 vertical EMC gasket, version 1,  
1 contact strip (three-part only)  
1 gasket strip (three-part only).

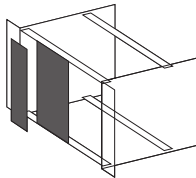
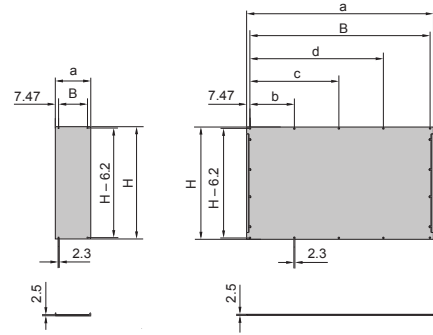

HP	a mm	W (B) mm	b mm	c mm	Model No. RP	
					3U H = 128.7	6U H = 262.05
4	20	--	--	--	9922108	9922128
4	20	--	--	--	PF30020	PF60020
5	25.1	--	--	--	9922506	9922509
5	25.1	--	--	--	PF30021	PF60021
9	45.4	--	--	--	PF30022	PF60022
10	50.5	35.6	--	--	PF30023	PF60023
15	75.9	61	--	--	PF30024	PF60024
20	101.3	86.4	--	--	PF30025	PF60025
24	121.7	106.7	--	--	PF30026	PF60026
25	126.7	111.8	--	--	PF30027	PF60027
29	147	132.1	--	--	PF30028	PF60028
30	152.1	137.2	--	--	PF30029	PF60029
35	177.5	162.6	--	--	PF30030	PF60030
40	202.9	188	91.6	--	PF30031	PF60031
45	228.3	213.4	106.6	--	PF30032	PF60032
50	253.7	238.8	119.4	--	PF30033	PF60033
55	279.1	264.2	132	--	PF30034	PF60034
60	304.5	289.6	96.6	192.8	PF30035	PF60035
65	329.9	315	105	210	PF30036	PF60036
70	355.3	340.4	113.4	126.8	PF30037	PF60037
75	380.7	365.8	121.8	243.6	PF30038	PF60038

Other variants available upon request.

### Part Number Configurator

PF U ID F G C

PF = Panel Fillers \_\_\_\_\_

U = 3U or 6U \_\_\_\_\_

ID = Part No. Identifier \_\_\_\_\_

F = Fastening \_\_\_\_\_  
 0 = Screw(s) only \_\_\_\_\_  
 1 = Screw(s) + Plastic Collar(s) \_\_\_\_\_  
 2 = Screw(s) + Metal Collar(s) \_\_\_\_\_

G = Gasket \_\_\_\_\_  
 1 = Version 1 \_\_\_\_\_  
 2 = Version 2 \_\_\_\_\_

C = Coating \_\_\_\_\_  
 Blank = Chromate \_\_\_\_\_  
 1 = Anodized Front, Chromate remainder \_\_\_\_\_

## Front Panels, Handles



### Front panels hinged

**Material:**  
2.5 mm Aluminium, anodised

**Supply includes:**  
1 set of hinges,  
assembly parts.

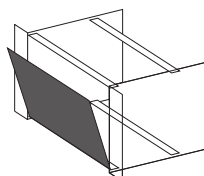

U	HP	Model No. RP	
		vertically hinged	horizontally hinged
3	42 <sup>1)</sup>	<b>3652.600</b>	<b>3652.500</b>
3	84 <sup>1)</sup>	<b>3652.610</b>	<b>3652.510</b>
3	85	–	<b>3684.291</b>
4	85	–	<b>3684.292</b>
6	42 <sup>1)</sup>	<b>3652.620</b>	<b>3652.520</b>
6	84 <sup>1)</sup>	<b>3652.630</b>	<b>3652.530</b>
6	85	–	<b>3684.293</b>
7	85	–	<b>3684.294</b>
9	85	–	<b>3684.295</b>

Custom sizes available upon request.

**Also required:**

<sup>1)</sup> With rear mounting of 42 HP and 84 HP front panels, additional trim sections must be attached at the rear of the subrack. Trim sections, see page 112.



### EMC front panels hinged

**Material:**  
2.5 mm aluminium, clear-chromated

**Supply includes:**  
1 front panel,  
1 set of hinges,  
1 contact strip,  
1 gasket strip,  
1 vertical EMC gasket, version 1,  
assembly parts.

**EMC**

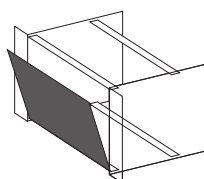

U	HP	Model No. RP horizontally hinged
3	84	<b>3684.298</b>
4	84	<b>3684.299</b>
6	84	<b>3684.300</b>
7	84	<b>3684.301</b>
9	84	<b>3684.302</b>

Custom sizes available upon request.

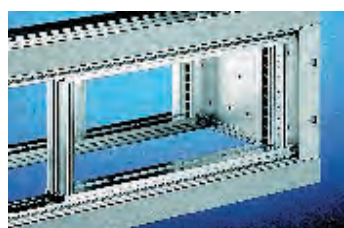

### Door cut-out trim for subracks

**Material:**  
Aluminium

Width	Packs of	Model No. UN
269.2 mm (1½ 19")	2	<b>3634.060</b>
482.6 mm (19")	2	<b>3634.070</b>

Front Panels: for Subracks

Handles: for Subracks

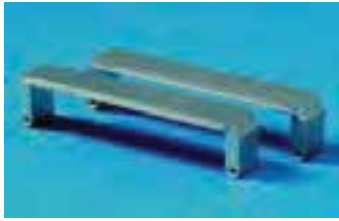

**Mezzanine front panels**  
**Extruded aluminium section**

For PCI mezzanine cards (PMC).

Conforms to IEEE 1386

**Material/surface finish:**

Extruded aluminium section, clear-chromated

Packs of	Model No. RP
1	3688.658

**+ Accessories:**

EMC seals,  
see page 154.  
Assembly screws M2.5 x 6  
packs of 100, Model No. RP 3654.340,  
see page 159.



**Mezzanine front panels**  
**Die-cast zinc**

For PCI mezzanine cards (PMC).

Conforms to IEEE 1386

**Material:**

Die-cast zinc

Packs of	Model No. RP
1	3688.659

**+ Accessories:**

EMC seals,  
see page 154.  
Assembly screws M2.5 x 6  
packs of 100, Model No. RP 3654.340,  
see page 159.



**Support spacers**

**for mezzanine cards**

10 mm, for mounting mezzanine cards.

Packs of	Model No. RP
1	3688.663



**Covers**  
**for mezzanine cut-outs**

To conceal unused mezzanine cut-outs.  
The covers are simply clipped into the cut-outs.

**Material:**

Stainless steel

Packs of	Model No. RP
1	3688.660



**EMC seals**

**for mezzanine front panels**

can be inserted into the all-round channel of the mezzanine front panels.

**Material/surface finish:**

Sealing ring made of 1.1 mm conductive carbon filled silicon, sealing gasket made from 0.18 mm (0.9 mm coil) stainless steel.

Design	Packs of	Model No. RP
Sealing ring	1	3688.661
Sealing gasket	1	3688.662

## Ripac Box Type Plug-In Units - Individual Components



### Vertical drive chassis

For the installation of drives or CD-ROMs. May be installed in all Ripac subracks.

- Optionally prepared for EMC or non-EMC
- Accomodation for 3 1/2" or 5 1/4" drives or CD-ROM, vertical
- Front panel and support plate integrated

### Material:

Front panel: 2.5 mm aluminium  
Support plate: Aluminium

### Surface finish:

Clear-chromated

### Supply includes:

1 front panel with support plate  
1 EMC gasket (with EMC modules) assembly parts.



Installation drives	Front panel		Depth of drive approx. mm	Front panel cut-out		Model No. RP	
	U (HE)	HP (TE)		Height (H) mm	Width (B) mm	EMC	Non-EMC
1 x 3 1/2"	3	8	160	102	26	<b>3684.469</b>	<b>3685.078</b>
1 x 5 1/4"	6	10	220	147	41.5	<b>3684.481</b>	<b>3685.090</b>
1 x 3 1/2"	3	8	160	–	–	–	<b>3685.091</b>
	3	10	160	–	–	–	<b>3685.092</b>
2 x 3 1/2"	6	8	160	–	–	–	<b>3685.095</b>
	6	10	160	–	–	–	<b>3685.096</b>

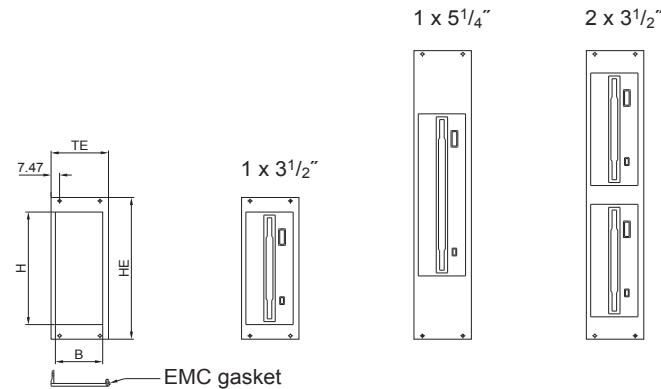

### Guide rails for drive chassis

For routing drive chassis in the subrack.

### Material:

Aluminium

### Supply includes:

Alignment pin.

For installation depth mm	Packs of	Model No. RP
160	1	<b>3686.989</b>

### Note:

Two guide rails are required for each drive chassis.  
Guide rail 4.4" for plastic drives, see page 130.



### Also required:

Assembly screws  
packs of 100, Model No. RP 3654.340, see page 159.



### PCB holder for box type plug-in units

For fastening PCBs in box type plug-in units.

### Material:

PBTP, basic material to UL94-V0

### Supply includes:

Assembly parts.

Packs of	Model No. RP
2	<b>3606.321</b>



# Ripac Box Type Plug-In Units – Type I



## Ripac box type plug-in units, type I

**Technical specifications:**  
 Installation depth: 160 and 220 mm  
 Height: 3 U and 6 U  
 to IEC 60 297-3,  
 Rear panel to accommodate individual connectors

**Material:**  
 Front panel: 2.5 mm aluminium, natural anodised  
 Rear panel: 2 mm aluminium, natural anodised  
 Side panel sections: Extruded aluminium section, natural anodised  
 Handle: Aluminium, natural anodised  
 PCB holder: Plastic

**Available upon request:**

- Box type plug-in units in special sizes or with printing
- EMC box type plug-in units with EMC front panels



**Accessories:**

Cover plants, see page 157.  
 Guide rails, see page 157.  
 Componets, see page 157.

HP	a mm	B mm	b mm	c mm	C mm	d mm	e mm	f mm	Model No. RP			
									3U	3U	6U	
<b>Board depth 160 mm</b>												
6	32.2	–	20.3	27.5	–	171.5	122	167	<b>3653.000</b>	–	–	
8	40.3	–	30.5	36.0	–	171.5	122	167	–	<b>3653.010</b>	–	
10	50.5	35.6	40.6	46.2	–	171.5	122	167	–	<b>3653.020</b>	<b>3653.100</b>	
12	60.6	45.7	50.8	56.4	–	171.5	122	167	–	<b>3653.030</b>	<b>3653.110</b>	
14	70.8	55.9	60.9	66.5	–	171.5	122	167	–	<b>3653.040</b>	<b>3653.120</b>	
21	106.3	91.4	96.4	102.0	86.3	171.5	122	167	–	<b>3653.050</b>	<b>3653.130</b>	
28	141.9	127.0	132.0	137.6	121.8	171.5	122	167	–	<b>3653.060</b>	<b>3653.140</b>	
42	213.1	198.1	203.2	208.8	193.0	171.5	122	167	–	<b>3653.070</b>	<b>3653.150</b>	
<b>Board depth 220 mm</b>												
10	50.5	35.6	40.6	46.2	–	231.5	182	227	–	<b>3653.200</b>	<b>3653.300</b>	
12	60.6	45.7	50.8	56.4	–	231.5	182	227	–	<b>3653.210</b>	<b>3653.310</b>	
14	70.8	55.9	60.9	66.5	–	231.5	182	227	–	<b>3653.220</b>	<b>3653.320</b>	
21	106.3	91.4	96.4	102.0	86.3	231.5	182	227	–	<b>3653.230</b>	<b>3653.330</b>	
28	141.9	127.0	132.0	137.6	121.8	231.5	182	227	–	<b>3653.240</b>	<b>3653.340</b>	
42	213.1	198.1	203.2	208.8	193.0	231.5	182	227	–	<b>3653.250</b>	<b>3653.350</b>	
<b>Supply includes</b>												
Front panel									1	1	1	
Handle									1	1	2	
Side panels									1	2	2	
Cover including rear panel									1	–	–	
Rear panel									–	1	2	
PCB holder									2	2	2	
Assembly parts (set)									1	1	1	

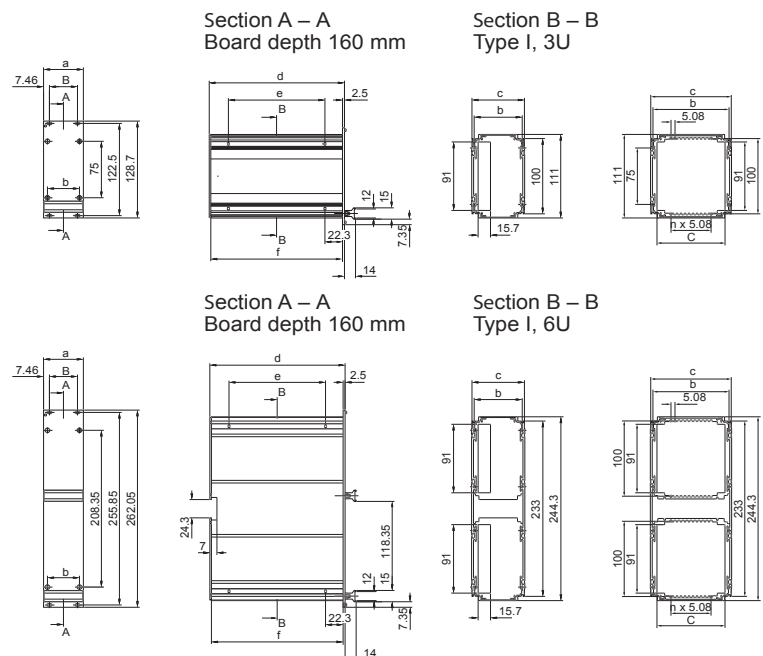

## Ripac Box Type Plug-In Units - Individual Components

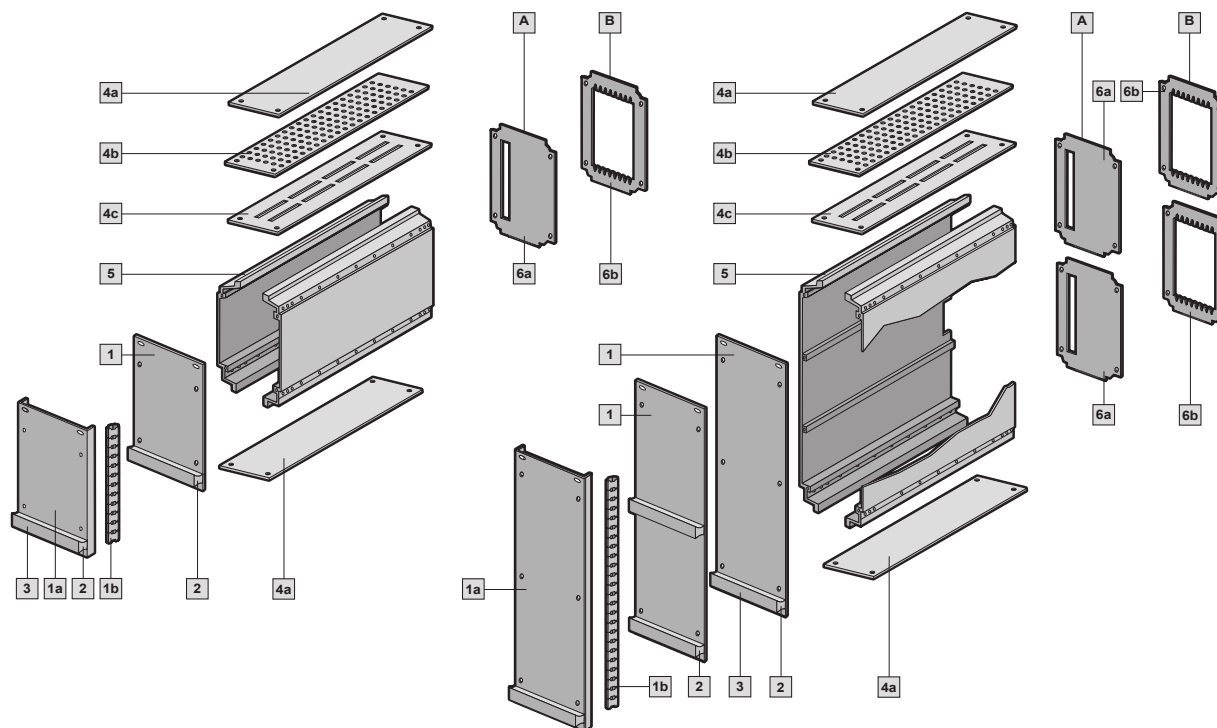

Ripac box type plug-in units, types I and II in 3U and 6U, individual components

Type I for one connector/type II for several connectors											
Box type plug-in units, individual components	A	B	Packs of	8 HP	10 HP	12 HP	14 HP	21 HP	28 HP	42 HP	Page
	Type I	Type II									
<b>Front panels</b> of 2.5 mm aluminium, anodised surface finish											
			1	3685.769	3685.629	3685.630	3685.631	3685.636	3685.637	3685.638	–
1			1	3685.767	3685.633	3685.634	3685.635	3685.639	3685.640	3685.641	–
			1	–	3687.520	3687.521	3687.522	3687.523	3687.524	3687.525	–
<b>EMC front panels</b> of 2.5 mm aluminium, surface finish clear-chromated (only for use in conjunction with 10 HP box type plug-in unit)											
1a			1	–	–	3687.587	–	–	–	–	–
			1	–	–	3687.588	–	–	–	–	–
<b>EMC gaskets, vertical, for front panels</b>											
1b			1	–	–	3686.975	–	–	–	–	124
			1	–	–	3686.977	–	–	–	–	124
<b>Handle type V</b>											
2			1	3685.600	3685.601	3685.602	3685.603	3685.761	3685.762	3685.763	149
			1	3685.492	–	3685.493	–	3685.494	–	–	149
<b>Identification strips</b>											
3			1	3685.751	3685.752	3685.753	3685.754	3685.755	3685.756	3685.757	149
<b>Top covers</b> 4a 4b of 1 mm aluminium, untreated 4c of 1.2 mm sheet steel, spray-finished, RAL 9006 (with vent slots)											
4a			1	3687.555	3685.689	3685.690	3685.691	3685.692	3685.693	3685.694	–
			1	3687.562	3685.701	3685.702	3685.703	3685.704	3685.705	3685.706	–
4b			1	3687.585	3685.683	3685.684	3685.685	3685.686	3685.687	3685.688	–
			1	–	3685.695	3685.696	3685.697	3685.698	3685.699	3685.700	–
4c			1	–	3687.556	3687.557	3687.558	3687.559	3687.560	3687.561	–
			1	–	3687.563	3687.564	3687.565	3687.566	3687.567	3687.568	–
<b>Side panel</b> of extruded aluminium section, anodised surface finish											
			1				3685.645				–
5			1				3685.648				–
			1				3685.646				–
			1				3685.649				–
<b>Rear panel</b> 6a of 2.0 mm aluminium, untreated 6b of 1.2 mm sheet steel, spray-finished											
6a			1	3687.536	3685.707	3685.708	3685.709	3685.710	3685.711	3685.712	–
6b			1	–	–	–	–	3687.537	3687.538	3687.539	–
<b>Assembly parts for box type plug-in units</b>											
<b>PCB holder for box type plug-in units</b>											



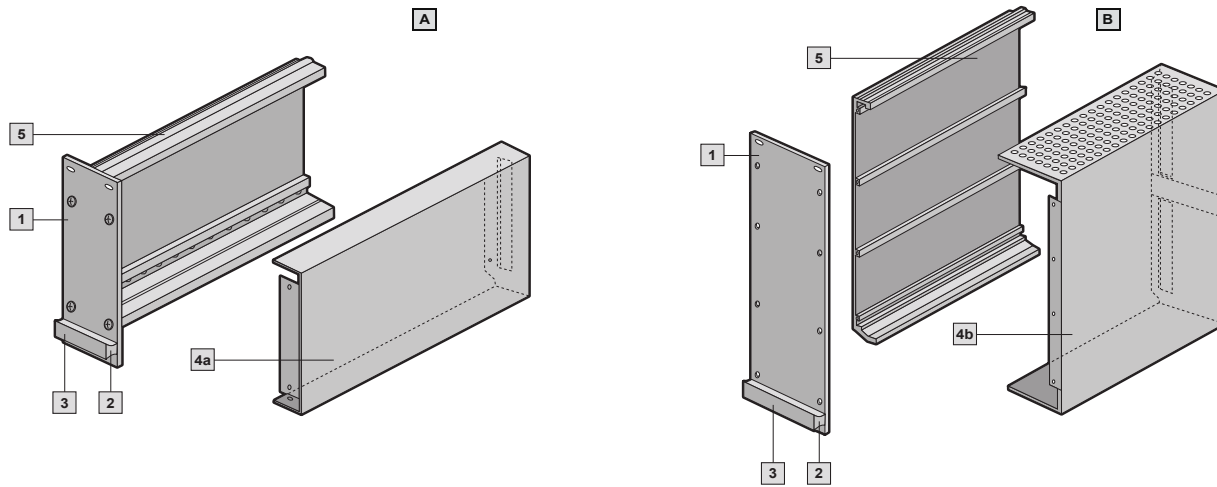









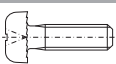



# Ripac Box Type Plug-In Units - Individual Components

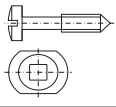

## Ripac box type plug-in units, types V and VI in 3U and 6U, individual components

Type V with cover (unvented)/type VI with cover (vented)											
Box type plug-in units, individual components	A	B	Packs of	6 HP	7 HP	8 HP	10 HP	12 HP	14 HP	Page	
	Type V	Type VI									
<b>Front panels</b> of 2.5 mm aluminium, anodised surface finish											
1	for 3U	■	1	3685.768	3685.628	3685.769	3685.629	3685.630	3685.631	–	
	for 6U	■	1	3685.766	3685.632	3685.767	3685.633	3685.634	3685.635	–	
<b>Handle type V</b>											
2	of aluminium, anodised surface finish	■	1	3685.598	3685.599	3685.600	3685.601	3685.602	3685.603	149	
	of plastic	■	1	–	–	3685.492	–	3685.493	–	149	
<b>Identification strips for 3U</b>											
3	of 0.5 mm aluminium, anodised surface finish	■	1	3685.749	3685.750	3685.751	3685.752	3685.753	3685.754	149	
<b>Cover</b> of 1 mm aluminium, clear-chromated surface finish											
4a	unvented, 3U, for board depth 160 mm	■	1	3685.774	3685.658	3685.776	3685.659	3685.660	3685.661	–	
	unvented, 3U, for board depth 220 mm	■	1	3685.775	3685.674	3685.777	3685.675	3685.676	3685.677	–	
	unvented, 6U, for board depth 160 mm	■	1	3685.717	3685.662	3685.764	3685.663	3685.664	3685.665	–	
	unvented, 6U, for board depth 220 mm	■	1	3685.718	3685.678	3685.765	3685.679	3685.680	3685.681	–	
4b	vented, 3U, for board depth 160 mm	–	1	3685.770	3685.650	3685.772	3685.651	3685.652	3685.653	–	
	vented, 3U, for board depth 220 mm	–	1	3685.771	3685.666	3685.773	3685.667	3685.668	3685.669	–	
	vented, 6U, for board depth 160 mm	–	1	3685.713	3685.654	3685.715	3685.655	3685.656	3685.657	–	
	vented, 6U, for board depth 220 mm	–	1	3685.714	3685.670	3685.716	3685.671	3685.672	3685.673	–	
<b>Side panel</b> of extruded aluminium section, anodised surface finish											
5	3U, for board depth 160 mm	■	1				3685.645			–	
	6U, for board depth 160 mm	■	1				3685.648			–	
	3U, for board depth 220 mm	■	1				3685.646			–	
	6U, for board depth 220 mm	■	1				3685.649			–	
<b>Assembly parts for box type plug-in unit types I, II, V, VI</b>											
Designation	For installation of:					Packs of	Model No. RP				
Assembly kit for box type plug-in unit I/II, 3U	Box type plug-in units, type I/II, 3U					1 set	3687.589				
Assembly kit for box type plug-in unit I/II, 6U	Box type plug-in units, type I/II, 6U					1 set	3687.590				
Assembly kit for box type plug-in unit type V/VI	Box type plug-in units, type V/VI					1 set	3685.294				
Assembly kit for box type plug-in unit with EMC front panel	Box type plug-in unit with EMC front panel					1 set	3687.591				
Assembly kit for plastic handles	Plastic handles on box type plug-in units					1 set	3687.519				
<b>Guide rails for box type plug-in units</b>											

## Assembly Parts

For the attachment of	Description	Dimensions		Model No.	Packs of
Front panels to unit side panels	Oval csk-screw ISO 7047-4.8-Z-A2K	M3 x 8		<b>3606.550</b>	100
Rear panels to box-type plug-in units	Panhead posidrive screw ISO 7045-4.8-Z-A2K	M3 x 8		<b>3606.560</b>	100
PCB holders (plastic) to front panels, top	Oval csk-screw ISO 7047-4.8-Z-A2K	M2.5 x 10		<b>3606.610</b>	100
– Horizontal rails to side panels – Divider panels to horizontal rails – Horizontal rails to vertical supports	Panhead self-locking screw similar to DIN ISO 7045-8.8-Z-A2K	M4 x 12		<b>3654.300</b>	100
Horizontal rails front/rear to side panels (Ripac EASY)	Multi-tooth assembly screw, self-tapping, T20, self-locking	M4 x 12		<b>3634.430</b>	100
Cover and base plates (Ripac EASY)	<b>Pozidrive</b> raised countersunk, multi-tooth assembly screw, T10, self-locking	M3 x 6		<b>3634.233</b>	100
– PCBs to PCB holders (die-cast for 3 U), top – PCBs to extractor handles with 6 U	Panhead posidrive screw ISO 7045-4.8-Z-A2K	M2.5 x 8		<b>3654.320</b>	100
– PCB holder (plastic) to type V/VI handles, bottom – PCBs to PCB holders (plastic) – Backplanes to threaded inserts	Panhead posidrive screw ISO 7045-4.8-Z-A2K	M2.5 x 10		<b>3654.330</b>	100
– Connectors to Z rails – Z rails to horizontal rails – Type V/VI handles to partial front panels, bottom right for ≥ 5 HP – Aluminium guide rails to horizontal rails – Mezzanine front panels	Panhead posidrive screw ISO 7045-4.8-Z-A2K	M2.5 x 6		<b>3654.340</b>	100
Aluminium guide rails to horizontal rails (fastening of square nuts)	Retaining cage	M2.5		<b>9901.417</b>	100
Handle type V (plastic) to front panels and box type plug-in units	Mounting kit for type V handle (plastic):  Cover black Cover grey Hex nut Screw Square nut DIN 562-04-A2K	M2.5 M2.5 x 16 M2.5 x 12 M2.5		<b>3687.519</b>	1 set
Connectors to PCBs	Panhead posidrive screw ISO 7045-4.8-Z-A2K	M2.5 x 12		<b>3654.350</b>	100
Guide rails (plastic) to horizontal rails	Screw for plastic WN 1413	M2.2 x 6		<b>3654.360</b>	100
– Flat front panels to handles type V, VI – Aluminium guide rails to horizontal rails	Square nut DIN 562-A2K	M2.5		<b>3654.370</b>	100
– Flat front panels to horizontal rails – Trim frame to conceal the front sections of the horizontal mounting kit	Collar screws (cheese-head) and plastic collars	M2.5 x 11		<b>3658.160</b>	100 sets
Flat front panels	Plastic collars			<b>3687.021</b>	100
PCB to type III handle	Screw for plastic WN 1412	3.0 x 8		<b>3658.190</b>	100
– PCBs to PCB holders (plastic) – PCB holders to front panels, top	Hex nut ISO 4032-8	M2.5		<b>3658.210</b>	100
– Backplanes to threaded inserts – Air partitions to horizontal rails	Mounting kit for backplanes:  Panhead posidrive screw ISO 7045-4.8-Z-A2K  Washer PE, natural DIN 125	M2.5 x 6  2.7	 	<b>3684.019</b>	100
– Covers to mounting blocks – EMC contact strips	Flat csk-screw ISO 7046-1-4.8-Z-A2K	M3 x 6		<b>3684.233</b>	100
Cover plates to side panels (Ripac Vario)	Mounting block			<b>3684.234</b>	10
Type V/VI handle to front panels	Bracket			<b>3684.435</b>	100
Female connector to PCB attachment	Pop rivet DIN 7340-B-CuZn	2.5 x 0.3 x 10		<b>3684.482</b>	100

## Assembly Parts

For the attachment of	Description	Dimensions	Model No.	Packs of
Ground contact to keyable guide rails	Fastening screw for ground contact	3.5 x 12	<b>3684.109</b>	50
Fans to fan mounting plate	Mounting kit for fans:  Flat csk-screw ISO 7046-1-4.8-Z-A2K  Hex nut ISO 4032-8  Serrated washer DIN 6798-A-Fst-A2K	M4 x 12  M4  4.3	<b>3685.197</b>	1 set
Covers to side panels	Mounting kit for covers:  Mounting block  Flat csk-screw ISO 7046-1-4.8-Z-A2K	   M3 x 6	<b>3685.256</b>	24 sets
PCB holders (die-cast) to front panels, top	Oval csk-screw ISO 7047-4.8-Z-A2K	M2.5 x 8	<b>3685.282</b>	100
– Covers/box type plug-in units type I/II – Contact/spring sections for 3-part front panels	Flat csk-screw ISO 7046-1-4.8-Z-A2K	M2.5 x 5	<b>3685.289</b>	100
– Handles on front panels for box type plug-in units – Front panels to hinge strips	Flat csk-screw ISO 7046-1-4.8-Z-A2K	M2.5 x 6	<b>3685.290</b>	100
Holder (horizontal assembly kit) to horizontal rail	Flat csk-screw similar to ISO 7046-1-4.8-Z-A2K	M2.5 x 5	<b>3686.916</b>	100
Holder (horizontal assembly kit) to horizontal rail	Flat csk-screw similar to ISO 7046-1-4.8-Z-A2K	M2.5 x 8	<b>3686.917</b>	100
Contact and spring sections on 3-part front panels without countersink	Panhead posidrive screw ISO 7046-4.8-Z-A2K	M2.5 x 5	<b>3686.924</b>	100
Recessed flanges to side panels	Mounting kit for recessed flanges:  Panhead self-locking screw similar to DIN ISO 7045-8.8-Z-A2K  Hex nut ISO 4032-8  Washer	M4 x 8  M4  4.3	<b>3687.015</b>	4 sets
Fastening the threaded inserts in horizontal rails	Grub screw ISO 7434-14H	M2.5 x 8	<b>3687.020</b>	100
– EMC front panels to horizontal rails – EMC trim frame to conceal the front sections of the horizontal mounting kit	Centering screw with slot, with slotted head	M2.5 x 11	<b>3687.050</b>	100
EMC front panels to horizontal rails	Centering screw, posidrive	M2.5 x 11	<b>3687.051</b>	100
EMC front panels to horizontal rails	Centering screw, hex socket	M2.5 x 11	<b>3688.709</b>	100
Front panels and rear panels to horizontal rails	Collar screw, with slotted head	M2.5 x 11	<b>3685.097</b>	100
Type V/VI handles (aluminium) to front panels	Mounting kit for type V/VI handles:  Panhead posidrive screw ISO 7045-4.8-Z-A2K  Bracket  Square nut DIN 562-11H-A2K	M2.5 x 6  M2.5	<b>3687.146</b>	1 set

Assembly parts:for electronic packaging

# Ripac Vario-Module System Enclosure



The RiCase instrument case impresses with its modern design and high functionality.

Particular features include the numerous colour variants and the all-metal enclosure construction.

The Ripac Vario-Module system enclosure (desktop or rack-mounted enclosure) is fully compatible with

the latest Ripac subrack range, making it ideal for individual configuration and assembly as a micro-computer system.

At just one U, the RiBox system enclosure offers a high packaging density in even the smallest of spaces.



### RiBox

**System enclosure** for horizontal installation of individual boards, hubs, routers and modems.

**Mounting plate** of sheet steel for individual population.

**Mounting kit** for horizontal installation of boards.

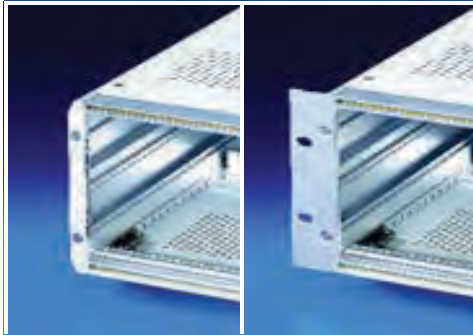

### Rittal RiCase

**All-metal instrument case for 482.6 mm (19") slide-in equipment**

The perfect "safe" for high-quality electronics. Extruded aluminium sections and die-cast elements form an extremely robust yet lightweight enclosure.

**Stability and non-slip properties** are guaranteed by 10 mm high corner caps. The distance from the desktop or from the lower enclosure offers excellent ventilation conditions.

**Slide-in strips** simply slide into the required profile channel, to facilitate any required attachment.



### Ripac Vario-Module

**System enclosure** for direct installation of PCBs or board-type plug-in units.

**Basic enclosure** optionally for EMC or non-EMC applications and suitable for individual configuration, e.g. with flanges/cover plates.

Optionally with **corner trim** for configuration as an instrument case or with **482.6 mm (19") flanges** for configuration as a rack-mounted enclosure.



### Overview of benefits

#### RiBox

- Horizontal installation of selected system components
- Standard mounting plate
- Minimal build height of 1U

#### Ripac Vario-Module

- Optional use as instrument case or rack-mounted enclosure
- Portable
- Optionally as EMC version

#### Rittal RiCase

- Instrument case for the installation of 482.6 mm (19") slide-in equipment and components
- All-metal design affords a high level of mechanical protection
- Ergonomic handle, feet and door variants
- For mobile and static use
- 3 colour variants as standard
- Configuration as a Tower version
- Front doors made from aluminium or acrylic
- Stackable

## RiBox System Enclosures 1U

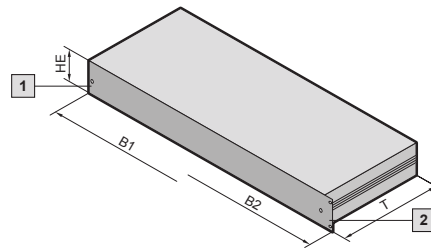
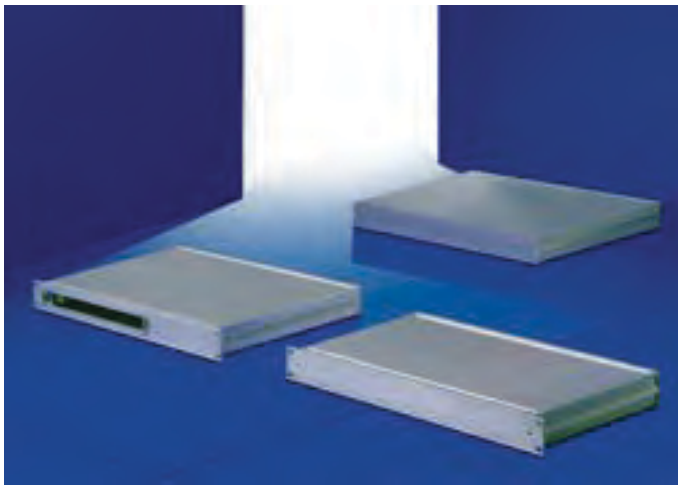

**Technical specifications:**  
System enclosures 1U, 150, 200, 250, 300, 350 mm deep  
Easy to assemble with just 4 screws.  
Optionally for use as an instrument case or 19" rack-mounted enclosure, front panel to hold an overlay to conceal the screws.  
Maximum possible useful interior space.  
Optional EMC upgrades with additional EMC gaskets.  
Option of installing 1 VME or CPCI board horizontally.

**Design:**  
System enclosure 1 U, to IEC 60 297-1.  
Optionally available for 19" rack-mounting in the enclosure or as an instrument case version.

- 1 Equipped as an instrument case**
- 2 Equipped as a rack-mounted unit**

**Material/surface finish:**  
Side panels:  
Extruded aluminium section, untreated  
Base/cover trays:  
Aluminium, clear-chromated  
Front/rear panel:  
Extruded aluminium section, clear-chromated  
Mounting plate:  
Sheet steel

Custom variations available upon request.

Detail drawing, see page 191.

U (HE)	1	1	1	1	1	–	–
Width (B1) mm	447	447	447	447	447	–	–
Width (B2) mm	19" (482.6)	19" (482.6)	19" (482.6)	19" (482.6)	19" (482.6)	19" (482.6)	19" (482.6)
Depth (T) mm	150	200	250	300	350	250	350
Model No. RP instrument case	3687.819	3687.820	3687.821	3687.822	3687.823	–	–
Model No. RP rack case	3687.814	3687.815	3687.816	3687.817	3687.818	–	–
Model No. RP rack-mount including mounting kit for double Euroboards	–	–	–	–	–	3684.072	3684.073
<b>Supply includes</b>							
Side panel	2	2	2	2	2	2	2
Font panel	1	1	1	1	1	1	1
Rear panel	1	1	1	1	1	1	1
Base/cover tray	2	2	2	2	2	2	2
Mounting kit	–	–	–	–	–	1	1
<b>Accessories</b>							
EMC set	3684.080	3684.080	3684.080	3684.080	3684.080	3684.080	3684.080
Mounting plate	3684.074	3684.075	3684.076	3684.077	3684.078	–	–



# Ripac Vario-Module 2U

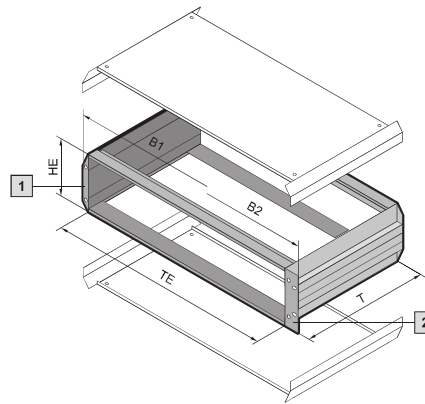

HE = U  
TE = HP

**Technical specifications:**  
May be used as a rack-mounted enclosure or instrument case. External dimensions to IEC 60 297-1 for installation in 482.6 mm (19") racks. Installation dimensions for board type plug-in assemblies to IEC 60 297-3-101.

**Material/Surface finish:**  
Side panels:  
Extruded aluminium section, spray-finished in RAL 7035  
Horizontal rails:  
Extruded aluminium section, clear-chromated  
Corner trims:  
Die-cast zinc, spray-finished in RAL 7035  
Side trims:  
Extruded aluminium section, spray-finished in RAL 7035

**Protection category:**  
IP 40 for non-vented version.

**Supply includes:**  
2 side panels,  
4 horizontal rails,  
4 threaded inserts,  
2 corner trims,  
assembly parts.

- 1 Equipped as an instrument case
- 2 Equipped as a rack-mounted unit

**Note:**  
Corner trims, mounting flanges and top and bottom covers must be ordered separately.

Horizontal rails for further configuration must be ordered separately, see pages 108-109.

Detailed drawings, see page 192.

**Horizontal rail configuration**

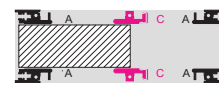

2 U

Custom variations available upon request.

Ripac Vario-Module	Packs of	2U						Page
Installation width (HP)		42	42	63	63	84	84	
Width (B1) mm		235.6	235.6	342.3	342.3	449.0	449.0	
Width (B2) mm		251.6	251.6	358.3	358.3	465.1	465.1	
Depth (T) mm		250.4	310.4	250.4	310.4	250.4	310.4	
Model No. VM Basic enclosure	1	3982.000	3982.020	3982.290	3982.300	3982.010	3982.030	

Also required								
Top covers								
– with vent holes	1	3982.941	3982.951	3982.942	3982.952	3982.940	3982.950	170
– without vent holes	1	3982.901	3982.911	3982.902	3982.912	3982.900	3982.910	170
Bottom covers								
– with vent holes	1	3982.741	3982.751	3982.742	3982.752	3982.740	3982.750	170
– without vent holes	1	3982.701	3982.711	3982.702	3982.712	3982.700	3982.710	170
Front corner trims for assembly as instrument case	2	3981.300	3981.300	3981.300	3981.300	3981.300	3981.300	171
Flanges for configuration as rack-mount								
– without handle holes	2	3981.200	3981.200	3981.200	3981.200	3981.200	3981.200	171

Accessories								
Front/rear panels								
Rear adjustable feet	4	3901.000	3901.000	3901.000	3901.000	3901.000	3901.000	172

# Ripac Vario-Module 2U, EMC

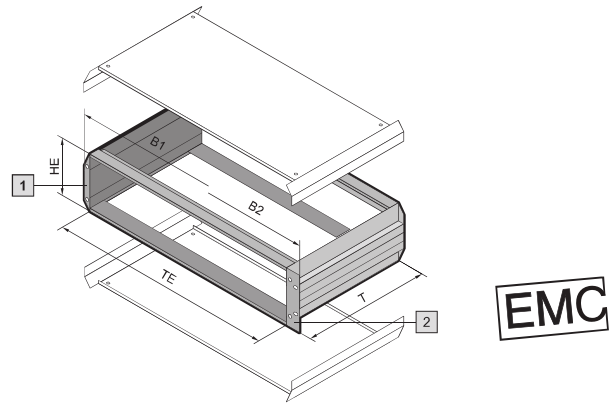

HE = U  
TE = HP

**Technical specifications:**  
May be used as a rack-mounted enclosure or instrument case.  
External dimensions to IEC 60 297-1 for installation in 482.6 mm (19") racks.  
Installation dimensions for board type plug-in assemblies to IEC 60 297-3-101.

**Material/Surface finish:**  
Side panels:  
Extruded aluminium section, spray-finished in RAL 7035  
Horizontal rails:  
Extruded aluminium section, clear-chromated  
Corner trims:  
Die-cast zinc, spray-finished in RAL 7035

**Side trims:**  
Extruded aluminium section, spray-finished in RAL 7035  
Contact points: conductive

**Protection category:**  
IP 40 for non-vented version.

**Supply includes:**  
2 side panels,  
4 horizontal rails,  
4 threaded inserts,  
2 rear corner trims,  
assembly parts.

- 1 Equipped as an instrument case
- 2 Equipped as a rack-mounted unit

**Note:**  
Corner trims, mounting flanges and top and bottom covers must be ordered separately.

Horizontal rails for further configuration must be ordered separately, see pages 108-109.

Detailed drawings, see page 192.

**Horizontal rail configuration**

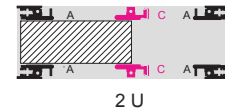

Custom variations available upon request.

Ripac Vario-Module	Packs of	2U						Page
Installation width (HP)		42	42	63	63	84	84	
Width (B1) mm		235.6	235.6	342.3	342.3	449.0	449.0	
Width (B2) mm		251.6	251.6	358.3	358.3	465.1	465.1	
Depth (T) mm		250.4	310.4	250.4	310.4	250.4	310.4	
<b>Model No. VM Basic enclosure EMC</b>	<b>1</b>	<b>3983.000</b>	<b>3983.020</b>	<b>3983.290</b>	<b>3983.300</b>	<b>3983.010</b>	<b>3983.030</b>	
<b>Also required</b>								
EMC top covers								
– with vent holes	1	3981.941	3981.951	3981.942	3981.952	3981.940	3981.950	170
– without vent holes	1	3981.901	3981.911	3981.902	3981.912	3981.900	3981.910	170
EMC bottom covers								
– with vent holes	1	3981.741	3981.751	3981.742	3981.752	3981.740	3981.750	170
– without vent holes	1	3981.701	3981.711	3981.702	3981.712	3981.700	3981.710	170
Front corner trims for assembly as instrument case	2	3981.300	3981.300	3981.300	3981.300	3981.300	3981.300	171
Flanges for configuration as rack-mount – without handle holes	2	3981.200	3981.200	3981.200	3981.200	3981.200	3981.200	171
<b>EMC installation</b>								
EMC gaskets, horizontal								
– for upper/lower horizontal rail	1	3684.808	3684.808	3684.808	3684.808	3684.808	3684.808	125
– between covers and horizontal rails	1	3684.245	3684.245	3684.245	3684.245	3684.245	3684.245	125
EMC gaskets, vertical	1	3686.974	3686.974	3686.974	3686.974	3686.974	3686.974	124
Front/rear panels EMC								
<b>Accessories</b>								
Front/rear panels								
Rear adjustable feet	4	3901.000	3901.000	3901.000	3901.000	3901.000	3901.000	172

# Ripac Vario-Module 3U

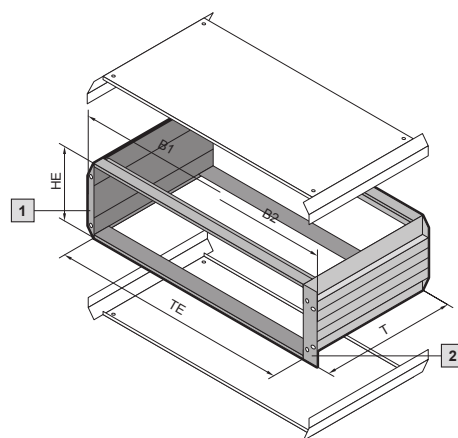

**Technical specifications:**  
 May be used as a rack-mounted enclosure or instrument case.  
 External dimensions to IEC 60 297-1 for installation in 482.6 mm (19") racks.  
 Installation dimensions for board type plug-in assemblies to IEC 60 297-3-101.

**Material/Surface finish:**  
 Side panels:  
 Extruded aluminium section, spray-finished in RAL 7035  
 Horizontal rails:  
 Extruded aluminium section, clear-chromated  
 Corner trims:  
 Die-cast zinc, spray-finished in RAL 7035  
 Side trims:  
 Extruded aluminium section, spray-finished in RAL 7035

**Protection category:**  
 IP 40 for non-vented version.

**Supply includes:**  
 2 side panels,  
 4 horizontal rails,  
 4 threaded inserts,  
 2 corner trims,  
 assembly parts.

**1** Equipped as an instrument case

**2** Equipped as a rack-mounted unit

**Note:**  
 Corner trims, mounting flanges and top and bottom covers must be ordered separately.

Horizontal rails for further configuration must be ordered separately, see pages 108-109.

Detailed drawings, see page 192.

**Horizontal rail configuration**

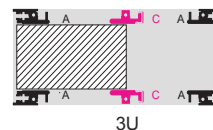

3U

Custom variations available upon request.

Ripac Vario-Module	Packs of	3U							Page
Installation width (HP)		42	42	63	63	84	84	84	
Width (B1) mm		235.6	235.6	342.3	342.3	449.0	449.0	449.0	
Width (B2) mm		251.6	251.6	358.3	358.3	465.1	465.1	465.1	
Depth (T) mm		250.4	310.4	250.4	310.4	250.4	310.4	370.4	
Model No. VM Basic enclosure	1	3982.040	3982.070	3982.050	3982.080	3982.060	3982.090	3982.100	
<b>Also required</b>									
Top covers									
– with vent holes	1	3982.941	3982.951	3982.942	3982.952	3982.940	3982.950	3982.960	170
– without vent holes	1	3982.901	3982.911	3982.902	3982.912	3982.900	3982.910	3982.920	170
Bottom covers									
– with vent holes	1	3982.741	3982.751	3982.742	3982.752	3982.740	3982.750	3982.760	170
– without vent holes	1	3982.701	3982.711	3982.702	3982.712	3982.700	3982.710	3982.720	170
Front corner trims for assembly as instrument case	2	3981.310	3981.310	3981.310	3981.310	3981.310	3981.310	3981.310	171
Flanges for configuration as rack-mount									
– without handle holes	2	3981.210	3981.210	3981.210	3981.210	3981.210	3981.210	3981.210	171
– with handle holes	2	3981.260	3981.260	3981.260	3981.260	3981.260	3981.260	3981.260	171
<b>Accessories</b>									
Front/rear panels									
Carrying handles	2	3981.350	3981.360	3981.350	3981.360	3981.350	3981.360	3981.370	171
Front handles <sup>1)</sup>	2	3636.010	3636.010	3636.010	3636.010	3636.010	3636.010	3636.010	171
Acrylic front door	1	3981.420	3981.420	3981.430	3981.430	3981.440	3981.440	3981.440	172
Rear adjustable feet	4	3901.000	3901.000	3901.000	3901.000	3901.000	3901.000	3901.000	172

<sup>1)</sup> Only in conjunction with mounting flanges with handle holes.

# Ripac Vario-Module 3U, EMC

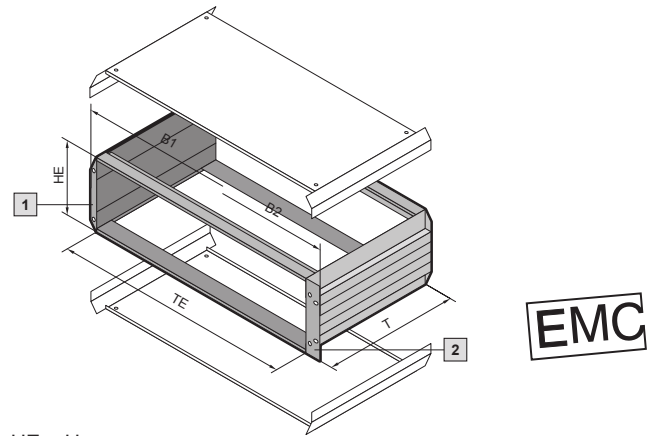
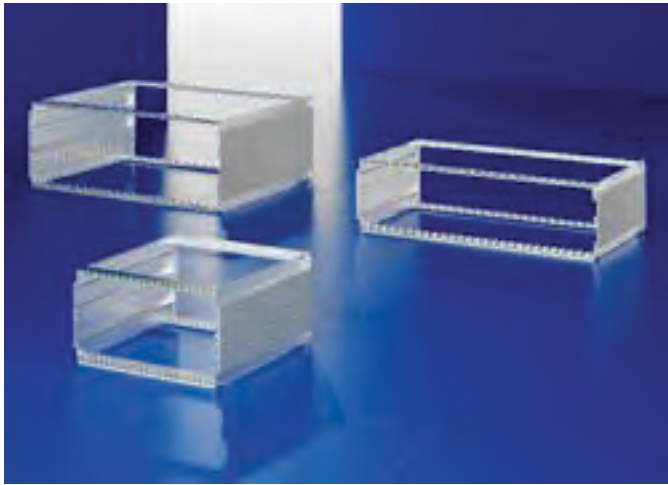

HE = U

**Technical specifications:**  
 May be used as a rack-mounted enclosure or instrument case.  
 External dimensions to IEC 60 297-1 for installation in 482.6 mm (19") racks.  
 Installation dimensions for board type plug-in assemblies to IEC 60 297-3-101.

**Material/Surface finish:**  
 Side panels:  
 Extruded aluminium section, spray-finished in RAL 7035  
 Horizontal rails:  
 Extruded aluminium section, clear-chromated  
 Corner trims:  
 Die-cast zinc, spray-finished in RAL 7035

**Side trims:**  
 Extruded aluminium section, spray-finished in RAL 7035  
 Contact points: conductive

**Protection category:**  
 IP 40 for non-vented version.

**Supply includes:**  
 2 side panels,  
 4 horizontal rails,  
 4 threaded inserts,  
 2 rear corner trims, assembly parts.

- 1 Equipped as an instrument case
- 2 Equipped as a rack-mounted unit

**Note:**  
 Corner trims, mounting flanges and top and bottom covers must be ordered separately.

Horizontal rails for further configuration must be ordered separately, see pages 108-109.

Detailed drawings, see page 192.

**Horizontal rail configuration**

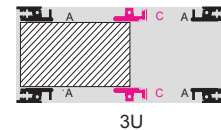

Custom variations available upon request.

Ripac Vario-Module	Packs of	3U							Page
<b>Installation width (HP)</b>		42	42	63	63	84	84	84	
<b>Width (B1) mm</b>		235.6	235.6	342.3	342.3	449.0	449.0	449.0	
<b>Width (B2) mm</b>		251.6	251.6	358.3	358.3	465.1	465.1	465.1	
<b>Depth (T) mm</b>		250.4	310.4	250.4	310.4	250.4	310.4	370.4	
<b>Model No. VM Basic enclosure EMC</b>	1	<b>3983.040</b>	<b>3983.070</b>	<b>3983.050</b>	<b>3983.080</b>	<b>3983.060</b>	<b>3983.090</b>	<b>3983.100</b>	
<b>Also required</b>									
EMC top covers									
– with vent holes	1	3981.941	3981.951	3981.942	3981.952	3981.940	3981.950	3981.960	170
– without vent holes	1	3981.901	3981.911	3981.902	3981.912	3981.900	3981.910	3981.920	170
EMC bottom covers									
– with vent holes	1	3981.741	3981.751	3981.742	3981.752	3981.740	3981.750	3981.760	170
– without vent holes	1	3981.701	3981.711	3981.702	3981.712	3981.700	3981.710	3981.720	170
Front corner trims for assembly as instrument case	2	3981.310	3981.310	3981.310	3981.310	3981.310	3981.310	3981.310	171
Flanges for configuration as rack-mount									
– without handle holes	2	3981.210	3981.210	3981.210	3981.210	3981.210	3981.210	3981.210	171
– with handle holes	2	3981.260	3981.260	3981.260	3981.260	3981.260	3981.260	3981.260	171
<b>EMC installation</b>									
EMC gaskets, horizontal									
– for upper/lower horizontal rail	1	3684.808	3684.808	3684.808	3684.808	3684.808	3684.808	3684.808	125
– between covers and horizontal rails	10	3684.245	3684.245	3684.245	3684.245	3684.245	3684.245	3684.245	125
EMC gaskets, vertical	1	3686.975	3686.975	3686.975	3686.975	3686.975	3686.975	3686.975	124
Front/rear panels EMC									
<b>Accessories</b>									
Front/rear panels									
Carrying handles	2	3981.350	3981.360	3981.350	3981.360	3981.350	3981.360	3981.370	171
Front handles <sup>1)</sup>	2	3636.010	3636.010	3636.010	3636.010	3636.010	3636.010	3636.010	171
Acrylic front door	1	3981.420	3981.420	3981.430	3981.430	3981.440	3981.440	3981.440	172
Rear adjustable feet	4	3901.000	3901.000	3901.000	3901.000	3901.000	3901.000	3901.000	172

<sup>1)</sup>Only in conjunction with mounting flanges with handle holes.

# Ripac Vario-Module 4U, 6U, 7U

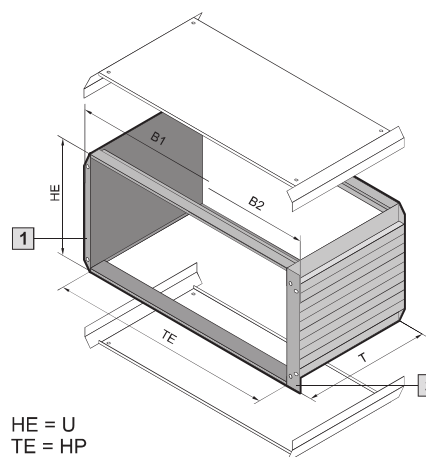

**Technical specifications:**  
May be used as a rack-mounted enclosure or instrument case. External dimensions to IEC 60 297-1 for installation in 482.6 mm (19") racks. Installation dimensions for board type plug-in assemblies to IEC 60 297-3-101.

**Material/surface finish:**  
Side panels: Extruded aluminium section, spray-finished in RAL 7035  
Horizontal rails: Extruded aluminium section, clear-chromated  
Corner trims: Die-cast zinc, spray-finished in RAL 7035

**Protection category:**  
IP 40 for non-vented version.

**Supply includes:**  
2 side panels,  
4 horizontal rails,  
4 threaded inserts,  
2 rear corner trims,  
2 side trims centre,  
assembly parts.

**1** Equipped as an instrument case

**2** Equipped as a rack-mounted unit

**Note:**  
Corner trims, mounting flanges and top and bottom covers must be ordered separately.

Horizontal rails for further configuration must be ordered separately, see pages 108-109.

Detailed drawings, see page 192.

Custom variations available upon request.

**Horizontal rail configuration**

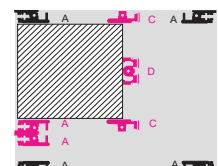
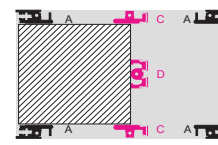
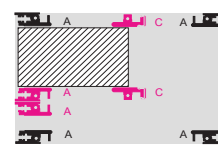

Ripac Vario-Module	Packs of	4U (3 + 1)			6U			7U (6 + 1)		Page
Installation width (HP)		84	84	84	84	84	84	84	84	
Width (B1) mm		449.0	449.0	449.0	449.0	449.0	449.0	449.0	449.0	
Width (B2) mm		465.1	465.1	465.1	465.1	465.1	465.1	465.1	465.1	
Depth (T) mm		250.4	310.4	370.4	310.4	370.4	430.4	310.4	430.4	
Model No. VM Basic enclosure	1	3982.110	3982.120	3982.130	3982.140	3982.150	3982.160	3982.170	3982.190	
<b>Also required</b>										
Top covers										
– with vent holes	1	3982.940	3982.950	3982.960	3982.950	3982.960	3982.970	3982.950	3982.970	170
– without vent holes	1	3982.900	3982.910	3982.920	3982.910	3982.920	3982.930	3982.910	3982.930	170
Bottom covers										
– with vent holes	1	3982.740	3982.750	3982.760	3982.750	3982.760	3982.770	3982.750	3982.770	170
– without vent holes	1	3982.700	3982.710	3982.720	3982.710	3982.720	3982.730	3982.710	3982.730	170
Front corner trims for assembly as instrument case	2	3981.320	3981.320	3981.320	3981.330	3981.330	3981.330	3981.340	3981.340	171
Flanges for configuration as rack-mount										
– without handle holes	2	3981.220	3981.220	3981.220	3981.230	3981.230	3981.230	3981.240	3981.240	171
– with handle holes	2	3981.270	3981.270	3981.270	3981.280	3981.280	3981.280	3981.290	3981.290	171
<b>Accessories</b>										
Front/rear panel		see page 184 – 199								
Carrying handles	2	3981.350	3981.360	3981.370	3981.360	3981.370	3981.380	3981.360	3981.380	171
Front handles <sup>1)</sup>	2	3636.010	3636.010	3636.010	3666.010	3666.010	3666.010	3666.010	3666.010	171
Acrylic front door	1	3981.450	3981.450	3981.450	3981.460	3981.460	3981.460	3981.470	3981.470	172
Rear adjustable feet	4	3901.000	3901.000	3901.000	3901.000	3901.000	3901.000	3901.000	3901.000	172

<sup>1)</sup> Only in conjunction with mounting flanges with handle holes.



# Ripac Vario-Module 4U, 6U, 7U, EMC

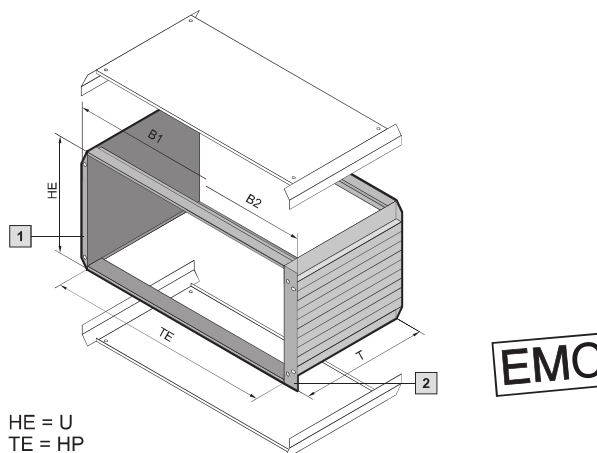

**Technical specifications:**  
 May be used as a rack-mounted enclosure or instrument case. External dimensions to IEC 60 297-1 for installation in 482.6 mm (19") racks. Installation dimensions for board type plug-in assemblies to IEC 60 297-3-101.

**Material/surface finish:**  
 Side panels: Extruded aluminium section, spray-finished in RAL 7035  
 Horizontal rails: Extruded aluminium section, clear-chromated  
 Corner trims: Die-cast zinc, spray-finished in RAL 7035  
 Contact points: conductive

**Protection category:**  
 IP 40 for non-vented version.

Supply includes:  
 2 side panels,  
 4 horizontal rails,  
 4 threaded inserts,  
 2 rear corner trims,  
 2 side trims centre, assembly parts.

**Note:**  
 Corner trims, mounting flanges and top and bottom covers must be ordered separately.

Detailed drawings, see page 192.

Custom variations available upon request.

- 1 Equipped as an instrument case
- 2 Equipped as a rack-mounted unit

Horizontal rails for further configuration must be ordered separately, see pages 108-109.

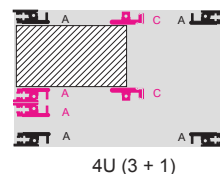

4U (3 + 1)

**Horizontal rail configuration**

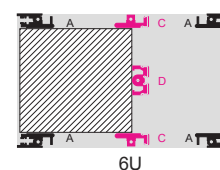

6U

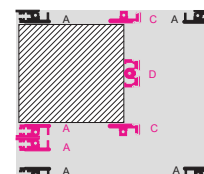

7U (6 + 1)

Ripac Vario-Module	Packs of	4U (3 + 1)			6U			7U (6 + 1)		Page
Installation width (HP)		84	84	84	84	84	84	84	84	
Width (B1) mm		449.0	449.0	449.0	449.0	449.0	449.0	449.0	449.0	
Width (B2) mm		465.1	465.1	465.1	465.1	465.1	465.1	465.1	465.1	
Depth (T) mm		250.4	310.4	370.4	310.4	370.4	430.4	310.4	430.4	
Model No. VM Basic enclosure EMC	1	3983.110	3983.120	3983.130	3983.140	3983.150	3983.160	3983.170	3983.190	

**Also required**

EMC top covers										
- with vent holes	1	3981.940	3981.950	3981.960	3981.950	3981.960	3981.970	3981.950	3981.970	170
- without vent holes	1	3981.900	3981.910	3981.920	3981.910	3981.920	3981.930	3981.910	3981.930	170
EMC bottom covers										
- with vent holes	1	3981.740	3981.750	3981.760	3981.750	3981.760	3981.770	3981.750	3981.770	170
- without vent holes	1	3981.700	3981.710	3981.720	3981.710	3981.720	3981.730	3981.710	3981.730	170
Front corner trims for assembly as instrument case	2	3981.320	3981.320	3981.320	3981.330	3981.330	3981.330	3981.340	3981.340	171
Flanges for configuration as rack-mount										
- without handle holes	2	3981.220	3981.220	3981.220	3981.230	3981.230	3981.230	3981.240	3981.240	171
- with handle holes	2	3981.270	3981.270	3981.270	3981.280	3981.280	3981.280	3981.290	3981.290	171

**EMC installation**

EMC gaskets, horizontal										
- for upper/lower horizontal rail	1	3684.808	3684.808	3684.808	3684.808	3684.808	3684.808	3684.808	3684.808	125
- between covers and horizontal rails	10	3684.245	3684.245	3684.245	3684.245	3684.245	3684.245	3684.245	3684.245	125
EMC gaskets, vertical	1	3686.976	3686.976	3686.976	3686.977	3686.977	3686.977	3686.978	3686.978	124
Front/rear panels EMC										

**Accessories**

Front/rear panel										
Carrying handles	2	3981.350	3981.360	3981.370	3981.360	3981.370	3981.380	3981.360	3981.370	171
Front handles <sup>1)</sup>	2	3636.010	3636.010	3636.010	3666.010	3666.010	3666.010	3666.010	3666.010	171
Acrylic front door	1	3981.450	3981.450	3981.450	3981.460	3981.460	3981.460	3981.470	3981.470	172
Rear adjustable feet	4	3901.000	3901.000	3901.000	3901.000	3901.000	3901.000	3901.000	3901.000	172

<sup>1)</sup> Only in conjunction with mounting flanges with handle holes.

# Ripac Vario-Module Accessories

## Enclosure population

For individual interior installation of the enclosures, system components from the Ripac range may be used.

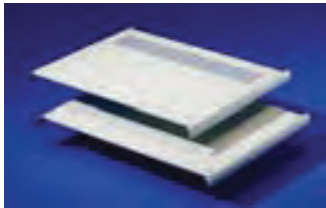

### Top Covers for Ripac Vario module

**Standard version**  
**Material:** Sheet steel, spray-finished  
**Colour:** RAL 7035

**EMC version**  
**Material:** Sheet steel, spray-finished  
 Contact points: conductive

HP	Depth mm	Model No. VM standard		Model No. VM EMC	
		with vent holes	without vent holes	with vent holes	without vent holes
42	250.4	3982.941	3982.901	3981.941	3981.901
	310.4	3982.951	3982.911	3981.951	3981.911
63	250.4	3982.942	3982.902	3981.942	3981.902
	310.4	3982.952	3982.912	3981.952	3981.912
84	250.4	3982.940	3982.900	3981.940	3981.900
	310.4	3982.950	3982.910	3981.950	3981.910
	370.4	3982.960	3982.920	3981.960	3981.920
	430.4	3982.970	3982.930	3981.970	3981.930

Custom variations available upon request.



### Bottom Covers for Ripac Vario module

**Standard version**  
**Material:** Sheet steel, spray-finished  
**Colour:** RAL 7035

**EMC version**  
**Material:** Sheet steel, spray-finished  
 Contact points: Conductive

HP	Depth mm	Model No. VM standard		Model No. VM EMC	
		with vent holes	without vent holes	with vent holes	without vent holes
42	250.4	3982.741	3982.701	3981.741	3981.701
	310.4	3982.751	3982.711	3981.751	3981.711
63	250.4	3982.742	3982.702	3981.742	3981.702
	310.4	3982.752	3982.712	3981.752	3981.712
84	250.4	3982.740	3982.700	3981.740	3981.700
	310.4	3982.750	3982.710	3981.750	3981.710
	370.4	3982.760	3982.720	3981.760	3981.720
	430.4	3982.770	3982.730	3981.770	3981.730

Custom variations available upon request.



**Feet**  
 with fold-out support stand.  
 Load capacity up to 20 kg.  
**Material:** Plastic  
**Colour:** RAL 7035

Packs of	Model No. VM
2	3919.000



**Mounting plate**  
 For mounting heavy components.  
**Material:** Aluminium  
**Supply includes:** Assembly parts.

HP	Depth mm	Packs of	Model No. VM
42	250	1	3982.370
63	250	1	3982.380
84	250	1	3982.390

## Ripac Vario-Module Accessories

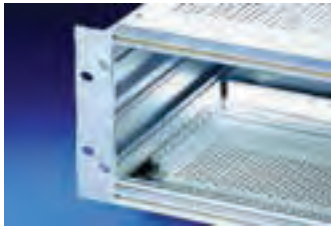
**Front Flanges**

Required when the Ripac Vario-Module is to be used as a rack-mounted enclosure. The flanges have a channel to accommodate vertical EMC gaskets.

**Material:**

Aluminium, clear-chromated

U	Packs of	Model No. VM	
		without handle hole	with handle hole
2	2	3981.200	–
3	2	3981.210	3981.260
4	2	3981.220	3981.270
6	2	3981.230	3981.280
7	2	3981.240	3981.290

**Accessories:**

Vertical EMC gasket, see page 124.

Front handles for mounting on front corner trim, see page 171.

**Front corner trims**

Required when the Ripac Vario-Module is to be used as a desk-top instrument case. The corner trims have a channel to accommodate vertical EMC gaskets.

**Material:**

Aluminium, spray-finished

**Colour:**

RAL 7035

U	Packs of	Model No. VM
2	2	3981.300
3	2	3981.310
4	2	3981.320
6	2	3981.330
7	2	3981.340

1 and 8U available on request.

**Accessories:**

Vertical EMC gasket, see page 124.

Front handles for mounting on front corner trim, see page 171.

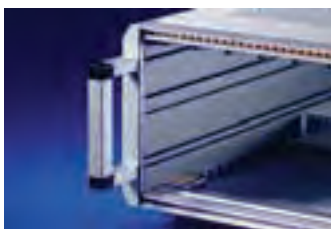
**Front handles**

For mounting on front corner trims

Maximum load capacity: 500 N

**Material:**

Cover: ABS

Handle part: Aluminium, clear anodised

**Supply includes:**

2 handle parts, 4 covers, assembly parts.

U	Packs of	Model No. VM
3	2	3982.350
4	2	3982.360
6	2	3982.400
7	2	3982.410

**Carrying handles**

For ergonomic transportation, even with stacked enclosures.

May also be used as a support stand.

Max. load capacity: 350 N.

**Material:**

Die-cast zinc and extruded aluminium section

**Colour:**

RAL 7035

**Note:**

Only for use with front and rear trims.

For enclosure depth mm	Packs of	Model No. VM
250.4	2	3981.350
310.4	2	3981.360
370.4	2	3981.370
430.4	2	3981.380



## Ripac Vario-Module Accessories



### Rear feet

For mounting on the rear of the enclosure.

Dual function:

- Mechanical protection of the connection components.
- Also act as a cable tidy during transportation.

**Material:**

PA, self-extinguishing to UL 94-V0

**Colour:**

RAL 7035

Packs of	Model No. VM
4	3901.000

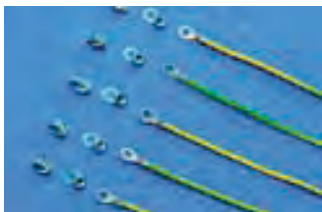

### Earthing set

For connecting the top and bottom covers to the side panels with PE conductors.

**Supply includes:**

Conductor cable green/yellow, 1.5 mm<sup>2</sup>, with washer, flat-pin connector and assembly parts.

Packs of	Model No. RP
5	3900.000

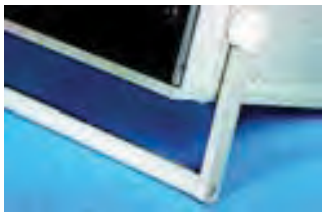

### Support stand/carrying handle

To fit Ripac Vario-Module 3U, 4U and 6U, adjustable on a 30° pitch pattern.

**Material:**

Extruded aluminium section/die-cast

**Colour:**

RAL 7035

**Supply includes:**

Assembly parts.

**Note:**

Corner trim for support stands/carrying handles should be ordered separately.

For Ripac Vario-Module	Packs of	Model No. VM
42 HP	1	3981.390
63 HP	1	3981.400
84 HP	1	3981.410

Corner trim for support stand	Packs of	Model No. VM
3U	2	3981.310
4U	2	3981.500
6U	2	3981.510



### Front doors

of acrylic glazing, horizontally hinged  
For protection of built-in control components.

**Material:**

Side parts: Aluminium, spray-finished in RAL 7035  
Window: Smoked acrylic

**Supply includes:**

Assembly parts.

U	For Ripac Vario-Module	Packs of	Model No. VM
3	42 HP	1	3981.420
3	63 HP	1	3981.430
3	84 HP	1	3981.440
4	84 HP	1	3981.450
6	84 HP	1	3981.460
7	84 HP	1	3981.470



### Front panels/rear panels

To cover the enclosures front and rear.  
Also available as a hinged or EMC version.  
Model No. see page 153.

## RiCase 269.2mm (1/2 19")

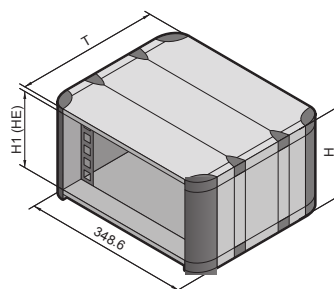

HE = U

**Technical specifications:**  
 Depth: 300 mm, 420 mm, 540 mm  
 Installation width:  
 269.2 mm (1/2 19")  
 Installation options:  
 269.2 mm (1/2 19") slide-in  
 equipment to IEC 60 297-3

**Material/surface finish:**

Covers:  
 Extruded aluminium section/  
 die-cast, spray-finished  
 Side panels:  
 Extruded aluminium section,  
 spray-finished  
 Corner caps: Plastic  
 482.6 mm (19") mounting  
 bracket:  
 Extruded aluminium section,  
 clear-chromated

**Colour:**  
 RAL 7035 (pale grey)

**Decorative colours and corner caps:**

RAL 5018 (turquoise)  
 RAL 5012 (pale blue)  
 RAL 7030 (stone grey)

**Protection category:**  
 IP 42 for unvented version.

**Supply includes:**  
 2 side panels,  
 2 covers,  
 8 corner caps,  
 8/12/16 cover caps  
 (300/420/540 mm depth),  
 4 482.6 mm (19") mounting  
 brackets,  
 4 threaded inserts,  
 2 plain inserts,  
 1 rear panel.  
 Enclosures are supplied  
 partially assembled.

**Special sizes and colours available on request.**

Property rights:  
 German registered design  
 no. 96 09 457  
 UK reg. design no. 2064682  
 US design patents  
 Des. 402,640 and Des. 423,464  
 Japan. reg. designs  
 no. 1045507 and 1045508  
 Detailed drawings,  
 see page 193.

Enclosures for subrack width 269.2 mm (1/2 19")		Packs of	1U		2U		3U			4 U		Page
<b>Height (H) mm</b>			77.5	77.5	121.9	121.9	166.4	166.4	166.4	210.8	210.8	
<b>H1 (U) mm</b>			45.0	45.0	89.4	89.4	133.8	133.8	133.8	178.3	178.3	
<b>Depth (T) mm</b>			300.0	420.0	300.0	540.0	300.0	420.0	540.0	420.0	540.0	
<b>Unvented</b>												
<b>Model No. RC, RAL 5018</b>		1	<b>3750.100</b>	–	<b>3750.200</b>	–	<b>3750.210</b>	<b>3750.300</b>	–	<b>3750.400</b>	–	
<b>Model No. RC, RAL 5012<sup>1)</sup></b>		1	<b>3750.102</b>	–	<b>3750.202</b>	–	<b>3750.212</b>	<b>3750.302</b>	–	<b>3750.402</b>	–	
<b>Model No. RC, RAL 7030<sup>1)</sup></b>		1	<b>3750.104</b>	–	<b>3750.204</b>	–	<b>3750.214</b>	<b>3750.304</b>	–	<b>3750.404</b>	–	
<b>Vented</b>												
<b>Model No. RC, RAL 5018</b>		1	–	<b>3750.110</b>	–	<b>3750.220</b>	–	<b>3750.350</b>	<b>3750.360</b>	–	<b>3750.450</b>	
<b>Model No. RC, RAL 5012<sup>1)</sup></b>		1	–	<b>3750.112</b>	–	<b>3750.222</b>	–	<b>3750.352</b>	<b>3750.362</b>	–	<b>3750.452</b>	
<b>Model No. RC, RAL 7030<sup>1)</sup></b>		1	–	<b>3750.114</b>	–	<b>3750.224</b>	–	<b>3750.354</b>	<b>3750.364</b>	–	<b>3750.454</b>	
<b>Weight (kg)</b>	vented/ unvented		3.3 3.4	4.2 4.4	3.7 3.8	5.4 6.1	4.1 4.2	5.2 5.4	6.1 6.8	5.8 6.0	6.8 7.5	
<b>Accessories</b>												
Carrying handles, horizontal		2	3751.250	3751.260	3751.250	3751.270	3751.250	3751.260	3751.270	3751.260	3751.270	176
	RAL 5018	1	3751.200	3751.200	3751.200	3751.200	3751.200	3751.200	3751.200	3751.200	3751.200	177
Support stand/ carrying handle	RAL 5012 <sup>1)</sup>	1	3751.202	3751.202	3751.202	3751.202	3751.202	3751.202	3751.202	3751.202	3751.202	177
	RAL 7030 <sup>1)</sup>	1	3751.204	3751.204	3751.204	3751.204	3751.204	3751.204	3751.204	3751.204	3751.204	177
Blanking plates (rear panel)		3	3746.000	3746.000	3747.000	3747.000	3748.000	3748.000	3748.000	3749.000	3749.000	–
Front door, vertically hinged		1	–	–	–	–	3751.300	3751.300	3751.300	3751.310	3751.310	177
Slide rails		2	3751.500	3751.510	3751.500	3751.520	3751.500	3751.510	3751.520	3751.510	3751.520	176
Mounting angles 482.6 mm (19")		2	3751.650	3751.650	3751.660	3751.660	3751.670	3751.670	3751.670	3751.680	3751.680	175
Threaded inserts with M4 thread		8	3751.700	3751.700	3751.710	3751.710	3751.720	3751.720	3751.720	3751.730	3751.730	175
End section		2	–	–	–	–	3751.900	3751.900	3751.900	3751.910	3751.910	176

<sup>1)</sup> Extended delivery times.

# RiCase 482.6mm (19")

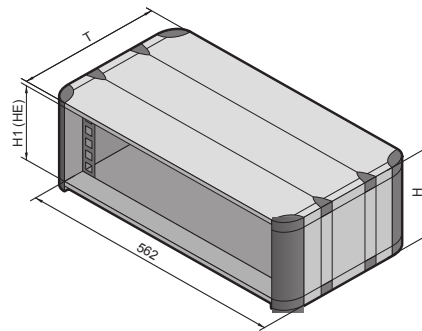

HE = U

**Technical specifications:**  
 Depth: 300 mm, 420 mm, 540 mm  
 Installation width:  
 482.6 mm (19")  
 Installation options:  
 482.6 mm (19") slide-in  
 equipment to IEC 60 297-3

**Material/surface finish:**  
 Covers:  
 Extruded aluminium section/  
 die-cast, spray-finished  
 Side panels:  
 Extruded aluminium section,  
 spray-finished  
 Corner caps: Plastic  
 482.6 mm (19") mounting  
 bracket:  
 Extruded aluminium section,  
 clear-chromated

**Colour:**  
 RAL 7035 (pale grey)  
**Decorative colours and  
 corner caps:**  
 RAL 5018 (turquoise)  
 RAL 5012 (pale blue)  
 RAL 7030 (stone grey)  
**Protection category:**  
 IP 42 for unvented version.

**Supply includes:**  
 2 side panels,  
 2 covers,  
 8 corner caps,  
 8/12/16 cover caps  
 (300/420/540 mm depth),  
 2 482.6 mm (19") mounting  
 brackets,  
 2 threaded inserts,  
 2 plain inserts.  
 Enclosures are supplied  
 partially assembled.

**Note:**  
 For rear installation, order back  
 panel/door separately.  
**Special sizes and colours  
 available on request.**  
 Detailed drawings,  
 see page 193.

Enclosure for subrack width 482.6 mm (19")	Packs of	3U		4U		6U			7U		9U		12U	Page
<b>Height (H) mm</b>		166.4	166.4	210.8	210.8	299.7	299.7	299.7	344.2	344.2	433.1	433.1	566.5	
H1 (U) mm		133.8	133.8	178.3	178.3	267.2	267.2	267.2	311.7	311.7	400.6	400.6	534.0	
<b>Depth (T) mm</b>		300.0	420.0	300.0	420.0	300.0	420.0	540.0	420.0	540.0	420.0	540.0	540.0	
<b>Not vented</b>														
<b>Model No. RC, RAL 5018</b>	1	3750.310	3750.320	3750.410	3750.420	3750.600	3750.610	3750.620	3750.700	3750.710	3750.900	3750.910	3750.000	
<b>Model No. RC, RAL 5012<sup>1)</sup></b>	1	3750.312	3750.322	3750.412	3750.422	3750.602	3750.612	3750.622	3750.702	3750.712	3750.902	3750.912	3750.002	
<b>Model No. RC, RAL 7030<sup>1)</sup></b>	1	3750.314	3750.324	3750.414	3750.424	3750.604	3750.614	3750.624	3750.704	3750.714	3750.904	3750.914	3750.004	
<b>Vented</b>														
<b>Model No. RC, RAL 5018</b>	1	3750.330	3750.340	3750.430	3750.440	3750.630	3750.640	3750.650	3750.720	3750.730	3750.920	3750.930	3750.030	
<b>Model No. RC, RAL 5012<sup>1)</sup></b>	1	3750.332	3750.342	3750.432	3750.442	3750.632	3750.642	3750.652	3750.722	3750.732	3750.922	3750.932	3750.032	
<b>Model No. RC, RAL 7030<sup>1)</sup></b>	1	3750.334	3750.344	3750.434	3750.444	3750.634	3750.644	3750.654	3750.724	3750.734	3750.924	3750.934	3750.034	
<b>Weight (kg)</b>	vented/ unvented	5.3 5.4	6.9 7.1	5.7 7.2	7.5 7.7	6.5 6.6	8.5 8.7	10.8 12.2	9.1 9.3	11.5 12.9	10.1 10.3	12.9 14.3	15.0 16.4	

**Accessories**

Carrying handles, horizontal	2	3751.250	3751.260	3751.250	3751.260	3751.250	3751.260	3751.270	3751.260	3751.270	3751.260	3751.270	3751.270	176
Support stand/ carrying handle	RAL 5018	1	3751.210	3751.210	3751.210	3751.210	3751.210	3751.210	3751.210	3751.210	3751.210	3751.210	3751.210	177
	RAL 5012 <sup>1)</sup>	1	3751.212	3751.212	3751.212	3751.212	3751.212	3751.212	3751.212	3751.212	3751.212	3751.212	3751.212	177
	RAL 7030 <sup>1)</sup>	1	3751.214	3751.214	3751.214	3751.214	3751.214	3751.214	3751.214	3751.214	3751.214	3751.214	3751.214	177
Back panel, screw-fastened	1	3751.600	3751.600	3751.610	3751.610	3751.620	3751.620	3751.620	3751.630	3751.630	3751.530	3751.530	3751.540	179
Rear door, vertically hinged	1	3751.100	3751.100	3751.110	3751.110	3751.120	3751.120	3751.120	3751.130	3751.130	-	-	-	179
Rear door for fan installation	1	3751.150	3751.150	3751.160	3751.160	3751.170	3751.170	3751.170	3751.180	3751.180	-	-	-	180
Front door, vertically hinged	1	3751.320	3751.320	3751.330	3751.330	3751.340	3751.340	3751.340	3751.350	3751.350	-	-	-	177
Slide rails	2	3751.500	3751.510	3751.500	3751.510	3751.500	3751.510	3751.520	3751.510	3751.520	3751.510	3751.510	3751.520	176
Mounting angles 482.6 mm (19")	2	3751.670	3751.670	3751.680	3751.680	3751.690	3751.690	3751.690	3751.640	3751.640	3751.780	3751.780	3751.790	175
Threaded inserts with M4 thread	8	3751.720	3751.720	3751.730	3751.730	3751.740	3751.740	3751.740	3751.750	3751.750	3751.760	3751.760	3751.770	175
End section	2	3751.900	3751.900	3751.910	3751.910	3751.920	3751.920	3751.920	3751.930	3751.930	3751.820	3751.820	3751.830	176

<sup>1)</sup> Extended delivery times.

## RiCase accessories

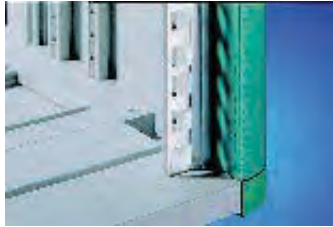

### Mounting angles 482.6 mm (19")

For front/rear installation of subracks and blanking plates.

**Material:**  
Extruded aluminium section, clear-chromated

**Supply includes:**  
Assembly parts.

**Note:**  
1 pack of threaded inserts and 2 packs of mounting rails and spacers are required for depth-adjustable installation.

For enclosure height	Packs of	Model No. RC
1U	2	3751.650
2U	2	3751.660
3U	2	3751.670
4U	2	3751.680
6U	2	3751.690
7U	2	3751.640
9U	2	3751.780
12U	2	3751.790

**!** Also required:

Threaded inserts, see page 175.  
Mounting rails, see page 175.  
Spacers, see page 175.



### Threaded inserts with M4 thread for RiCase

For the installation of mounting angles, slide rails, mounting kits, cable ducts etc. Simply slide into the channels in the side panels.

**Material:**  
Extruded aluminium section, clear-chromated

For enclosure height	Packs of	Model No. RC
1U	8	3751.700
2U	8	3751.710
3U	8	3751.720
4U	8	3751.730
6U	8	3751.740
7U	8	3751.750
9U	8	3751.760
12U	8	3751.770



### Mounting rails

- For depth-variable installation of mounting angles
- For the installation of component shelves, static or pull-out

**Material:**  
Aluminium, clear-chromated

**Supply includes:**  
Assembly parts.

For enclosure depth mm	Packs of	Model No. RC
300	2	3751.400
420	2	3751.410
540	2	3751.420

**!** Also required:

Threaded inserts, see page 175.  
Spacers, see page 175.

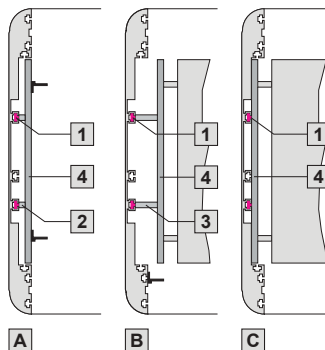

**A** Version for depth-variable mounting angles

**B** Component shelf installation for 482.6 mm (19") (width 409 mm, also with telescopic slides)

**C** Direct component shelf installation (width 471 mm)

- 1** Threaded inserts
- 2** Short spacers
- 3** Long spacers
- 4** Mounting rails



### Spacers

For the attachment of mounting rails.

Design	Packs of	Model No. RC
Short for depth-variable mounting bracket	4	3751.450
Long for component shelf installation (width 409 mm)	4	3751.460

## RiCase accessories



### Side rails

To support heavy installed equipment.

**Material:**

1.5 mm sheet steel, passivated

**Supply includes:**

Assembly parts.

For enclosure depth mm	Packs of	Model No. RC
300	2	3751.500
420	2	3751.510
540	2	3751.520



**Also required:**

Threaded inserts, see page 175.

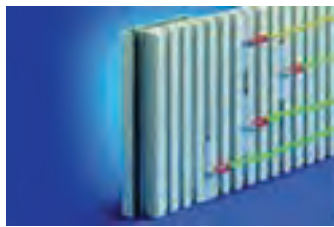

### Earthing set for RiCase

**for RiCase**

To meet electrical protective measures; fits all RiCase enclosures.

**Supply includes:**

Threaded insert, screw, green/yellow connection cable, serrated washer, nut.

Packs of	Model No. VC
4	3798.000

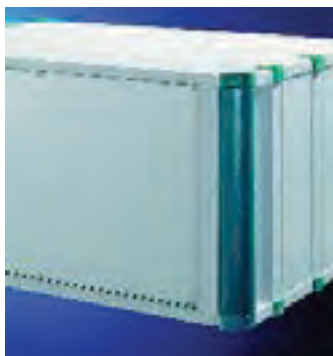

### Rear trim

To cover the sides to the left and right of the subrack when no rear door or rear panel is used.

**Material:**

Extruded aluminium section, spray-finished

**Colour:**

RAL 7035

**Supply includes:**

Assembly parts.

For enclosure height	Packs of	Model No. RC
3U	2	3751.900
4U	2	3751.910
6U	2	3751.920
7U	2	3751.930
9U	2	3751.820
12U	2	3751.830

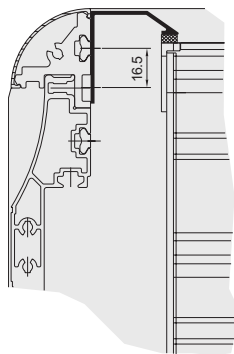

### Carrying handles

horizontal

For easy, secure transportation.

- May be retrofitted
- Load capacity 30 kg/pair

**Material:**

Side parts: Die-cast, spray-finished  
Centre part: Extruded aluminium section, spray-finished

**Colour:**

RAL 7035

**Supply includes:**

Assembly parts.

For enclosure depth mm	Packs of	Model No. RC
300	2	3751.250
420	2	3751.260
540	2	3751.270



## RiCase accessories



1



2



3

### Support stand/carrying handle

- Support stand/carrying handle adjustable in 30° increments
- Suitable for retrofitting to 2 – 7 U
- For 269.2 mm (1½ 19") and 482.6 mm (19") wide enclosures
- Load capacity 30 kg

#### Material:

Hinged part: Die-cast, spray-finished  
Centre part: Extruded aluminium section, spray-finished with plastic cover

#### Colour:

RAL 7035

Decorative colours:

- 1 RAL 7030 (stone grey)
- 2 RAL 5018 (turquoise)
- 3 RAL 5012 (pale blue)

#### Supply includes:

Assembly parts.

For enclosure width mm	Decorative colour RAL	W mm	Model No. RC
269.2 (1½ 19")	5018	392	<b>3751.200</b>
269.2 (1½ 19")	5012 <sup>1)</sup>	392	<b>3751.202</b>
269.2 (1½ 19")	7030 <sup>1)</sup>	392	<b>3751.204</b>
482.6 (19")	5018	605	<b>3751.210</b>
482.6 (19")	5012 <sup>1)</sup>	605	<b>3751.212</b>
482.6 (19")	7030 <sup>1)</sup>	605	<b>3751.214</b>

W = Overall width of handle

<sup>1)</sup> Extended delivery times.

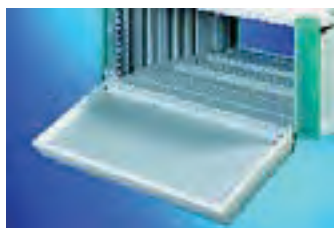
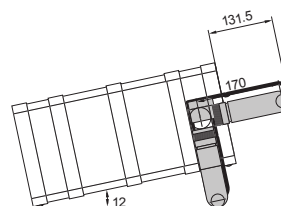

### Keyboard lid

Suitable for the installation of 482.6 mm (19") keyboards.

- Horizontally hinged with security lock
- Removable cover plate

#### Material:

Frame section: Extruded aluminium section/ die-cast, spray-finished  
Base and cover plate: Aluminium, spray-finished

#### Colour:

RAL 7035

#### Supply includes:

Assembly parts.

For enclosure width mm	H (U)	Packs of	Model No. RC
482.6 (19")	4	1	<b>3751.800</b>
482.6 (19")	6	1	<b>3751.810</b>

Note:

Use only in conjunction with support stand/ carrying handle.

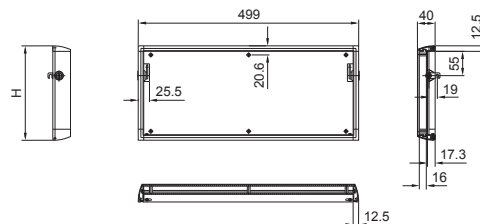

### Front door vertically hinged

For mechanical protection of built-in control components.

- Optionally hinged on the right or left
- With security lock

#### Material:

Frame section: Extruded aluminium section, spray-finished  
Corner pieces: Die-cast aluminium, spray-finished  
Glazed pane: Light grey acrylic

#### Colour:

RAL 7035

#### Supply includes:

Assembly parts.

For enclosure width mm	W (B) mm	H (U)	Model No. RC
269.2 (1½ 19")	289	3	<b>3751.300</b>
269.2 (1½ 19")	289	4	<b>3751.310</b>
482.6 (19")	503	3	<b>3751.320</b>
482.6 (19")	503	4	<b>3751.330</b>
482.6 (19")	503	6	<b>3751.340</b>
482.6 (19")	503	7	<b>3751.350</b>

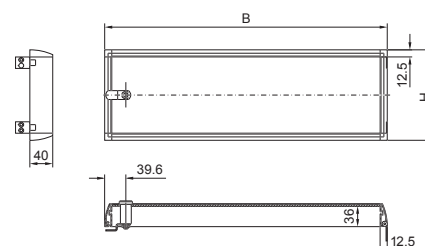

## RiCase accessories



### Aluminium front door vertically hinged

For mechanical protection of built-in control components.

- Optionally hinged on the right or left
- With security lock

**Material:**

Frame section: Extruded aluminium section, spray-finished  
 Corner pieces: Die-cast aluminium, spray-finished  
 Aluminium plate

**Colour:**  
 RAL 7035

**Supply includes:**  
 Assembly parts.

For enclosure width mm	W (B) mm	H (U)	Model No. RC
482.6 (19")	503	3	3751.360
482.6 (19")	503	4	3751.370
482.6 (19")	503	6	3751.380

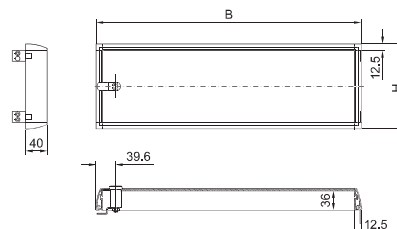

### Front door

#### for tower enclosure

For mechanical protection of built-in control components.

- Optionally hinged on the right or left
- With security lock

**Material:**

Frame section: Extruded aluminium section, spray-finished  
 Corner pieces: Die-cast aluminium, spray-finished  
 Glazed pane: Light grey acrylic

**Colour:**  
 RAL 7035

**Supply includes:**  
 Assembly parts.

For enclosure width mm	W mm	H (U)	Model No. RC
482.6 (19")	503	3	3751.390
482.6 (19")	503	4	3751.430

W = Overall width of front door

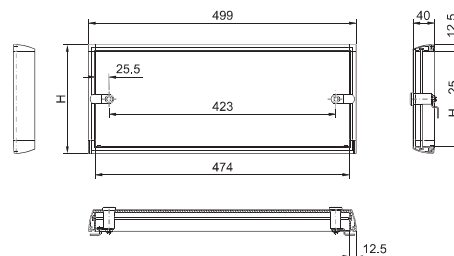

## RiCase accessories



1



2



3

### Tower feet

For vertical siting of enclosures.  
May be retrofitted.

**Material:**  
Plastic to UL 94-V0,  
self-extinguishing

**Decorative colours:**

- 1 RAL 7030 (stone grey)
- 2 RAL 5018 (turquoise)
- 3 RAL 5012 (pale blue)

**Supply includes:**  
4 tower feet,  
assembly parts.

Decorative colour RAL	Packs of	Model No. RC
5018	1 set	3751.850
5012	1 set	3751.852
7030	1 set	3751.854



### Back panel screw-fastened

To close off the rear.

**Material:**  
2/3 mm aluminium, natural anodised

**Supply includes:**  
Two 482.6 mm (19") mounting brackets,  
assembly parts.

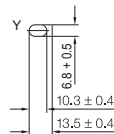
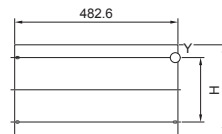

For enclosure width mm	H (U)	Packs of	Model No. RC
482.6 (19")	3	1	3751.600
482.6 (19")	4	1	3751.610
482.6 (19")	6	1	3751.620
482.6 (19")	7	1	3751.630
482.6 (19")	9	1	3751.530
482.6 (19")	12	1	3751.540

Custom variations available upon request.



### Rear door

#### vertically hinged

To close off the rear.

- Hinged, with security lock
- Optionally hinged on the left or right

**Material:**  
Aluminium, spray-finished

**Colour:**  
RAL 7035

**Supply includes:**  
Assembly parts.

For enclosure width mm	H (U)	Packs of	Model No. RC
482.6 (19")	3	1	3751.100
482.6 (19")	4	1	3751.110
482.6 (19")	6	1	3751.120
482.6 (19")	7	1	3751.130

Custom variations available upon request.

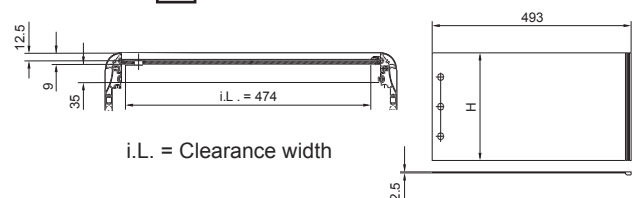



## RiCase accessories

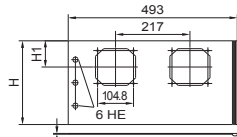

HE = U

### Rear door for fan installation

- To close off the rear.
- With security lock
  - Optionally hinged on the left or right
  - For the installation of 120 mm fans

**Material:**  
Aluminium, spray-finished

**Colour:**  
RAL 7035

**Supply includes:**  
Assembly parts.

For enclosure width mm	H (U)	H1 mm	Model No. RC
482.6 (19")	3	66.65	3751.150
482.6 (19")	4	88.90	3751.160
482.6 (19")	6	83.50	3751.170
482.6 (19")	7	83.50	3751.180

Custom variations available upon request.

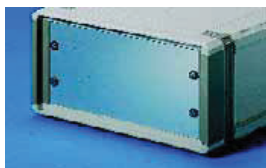

### Blanking plate

For the installation in electronic enclosures or housings.

**Material:**  
Aluminium, natural-anodised

U	Packs of	Model No. VC	
		269.2 mm (1/2 19")	482.6 mm (19")
1	3	3746.000	1931.200
2	3	3747.000	1932.200
3	3	3748.000	1933.200
4	3	3749.000	1934.200
6	3		1936.200
7	3		1935.200
9	3		1939.200
12	3		1937.200

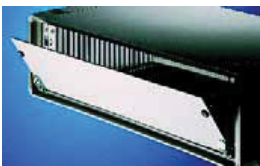

### Blanking plate horizontally hinged

For the installation in electronic enclosures or housings.

**Material:**  
3 mm aluminium, natural-anodised  
**Hinge:** Die-cast zinc, zinc-plated

**Supply includes:**  
Assembly parts.

Width	U	Packs of	Model No. EL
482.6 mm (19")	3	1	1944.000
482.6 mm (19")	6	1	1945.000



### Blanking plate vertically hinged

For the installation in electronic enclosures or housings.

**Material:**  
3 mm aluminium, natural-anodised  
**Hinge:** Die-cast zinc, zinc-plated

**Supply includes:**  
Assembly parts.

Width	U	Packs of	Model No. EL
482.6 mm (19")	3	1	1940.000
482.6 mm (19")	6	1	1941.000



### Hinge for blanking plates

**Material:**  
Die-cast zinc, zinc-plated

**Supply includes:**  
Assembly parts.

Packs of	Model No. EL
2	1950.000



### Assembly screws

**M6 x 15 mm**  
For electronic equipment, 482.6 mm (19") installed components and blanking plates.

**Supply includes:**  
Plastic washers.

Design	Packs of	Model No. EL
Cheese-head screw M6	100	2093.200
Phillips-head screw M6	100	2089.000

## RiCase accessories



### Captive nuts M6

For the attachment of rack-mounted electronic equipment, 482,6 mm (19 ") installed equipment and blanking plates to mounting angles, 482,6 mm (19").

For use with metal thickness from 0.8 – 2.0 mm. In areas of narrow tolerance, captive nuts for metal thicknesses of 1.2 – 1.5 mm should be used. Optionally with or without contact of the installed equipment to the 482.6 mm (19 ") section/ enclosure.

Design	For metal thicknesses mm	Packs of	Model No. EL
With contact	0.8 – 2.0	50	<b>2094.200</b>
Without contact	0.8 – 2.0	50	<b>2092.200</b>
With contact	1.2 – 1.5	50	<b>2094.300</b>
Without contact	1.2 – 1.5	50	<b>2092.300</b>

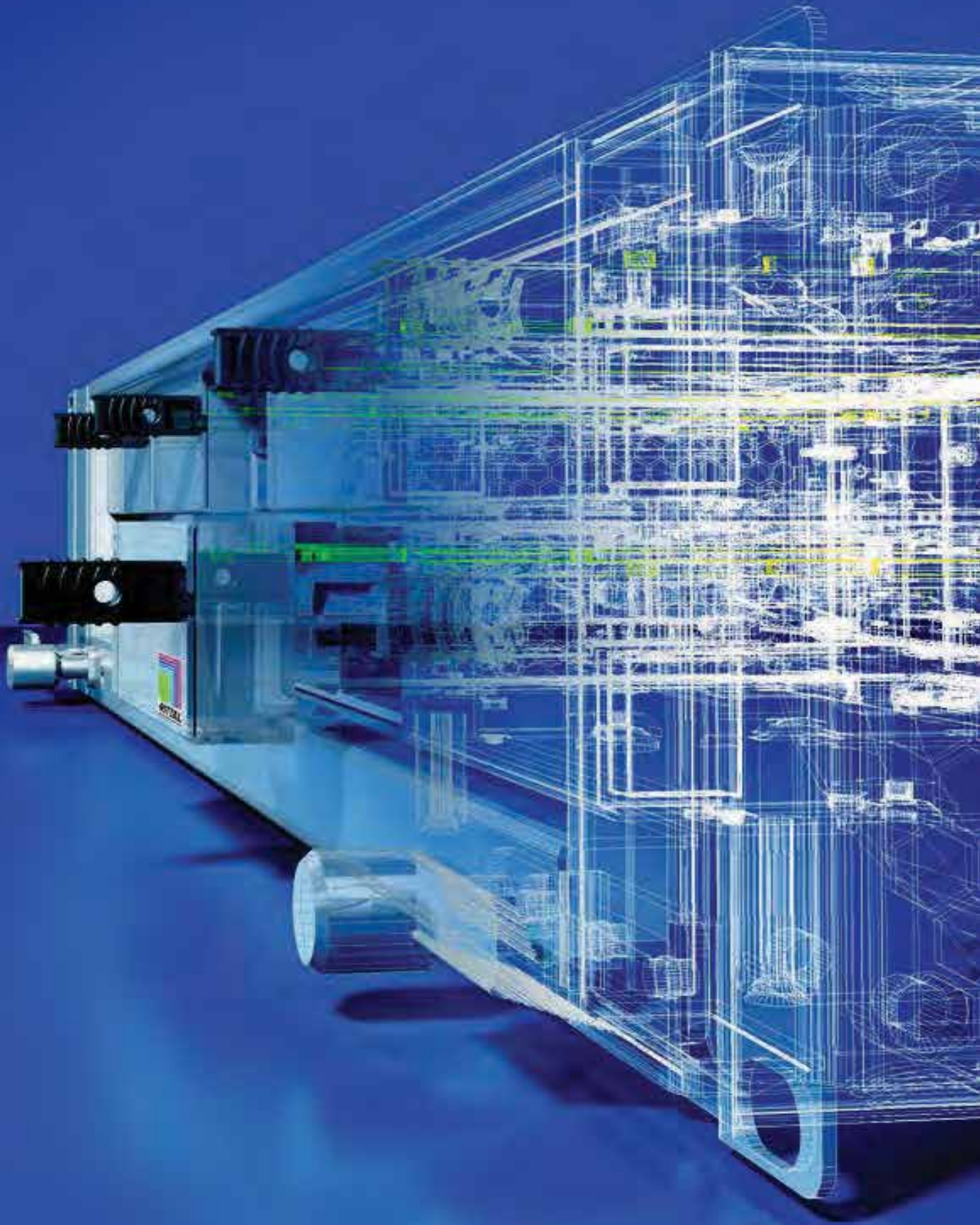

# Technical Details

Power supplies

from page 184

---

Subracks

from page 186

---

Instrument cases/system enclosures

from page 191

---

EMC diagram for Ripac Vario EMC

from page 194

---

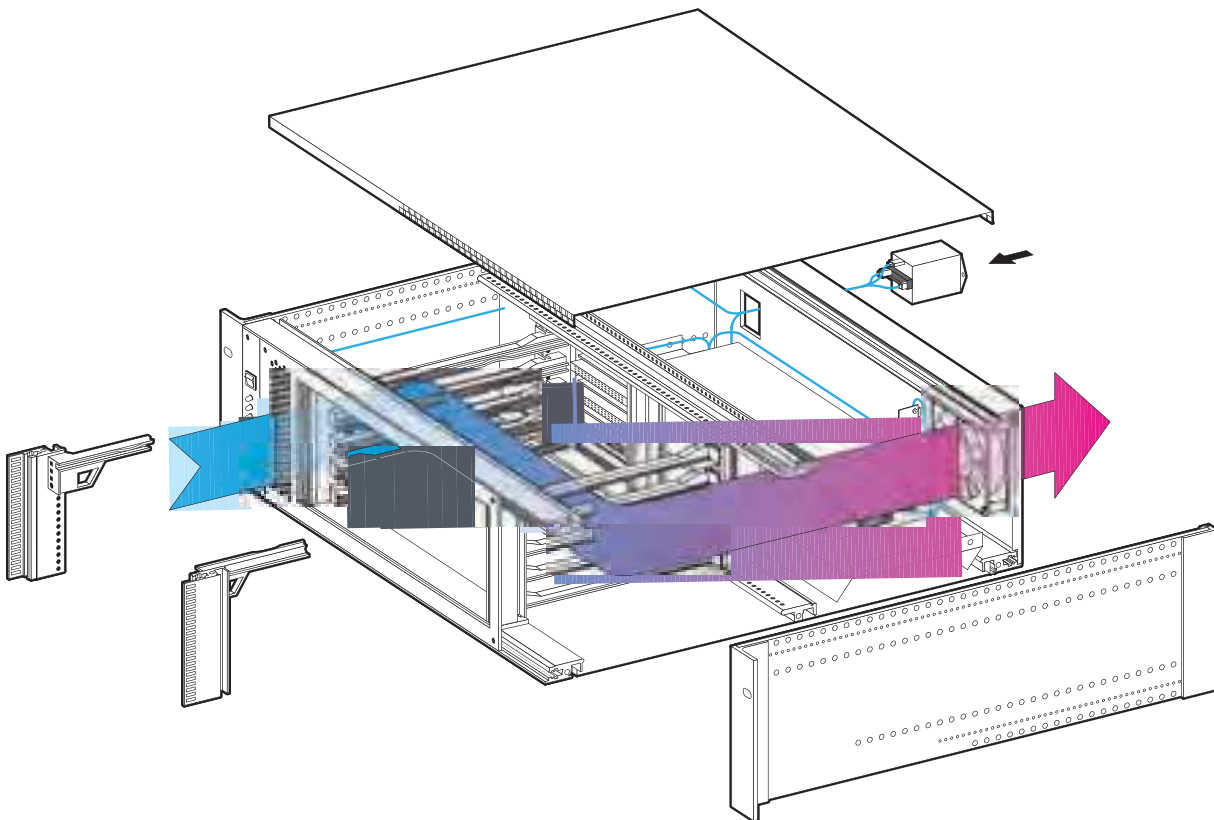



# Power supplies

## Ripac power supplies for VME, plug-in

### General specifications

Height	3U		6U	
Width (HP)	10	12	8	12
Model No. RP power supply	3686.469	3686.470	3686.471	3685.306
Model No. RP front panel	3685.304	3685.305	3686.472	3685.307
Operating temperature range	0°C to +70°C with free convection		0°C to +70°C with free convection	
Storage temperature	-20°C to +85°C		0°C to +85°C	
Output reduction	3 %/K from +50°C		3 %/K from +50°C	
Mass	10 HP: 0.7 kg, 12 HP: 0.8 kg		8 HP: 1.2 kg, 12 HP: 2 kg	
Mains buffering	> 20 ms at 100 % load		> 20 ms at 100 % load	
Radio interference suppression	EN 50 081-1, EN 55 011/EN 55 022 curve B Interfering radiation depending on installation		EN 50 081-1, EN 55 011/EN 55 022 curve B Interfering radiation depending on installation	
Immunity to interference/immission	EN 50 082-2 EN 61 000-4-2 Level 4 EN 61 000-4-3 Level 3 EN 61 000-4-4 Level 4 EN 61 000-4-5 Level 4 EN 61 000-4-11 compliant		EN 50 082-2 EN 61 000-4-2 Level 4 EN 61 000-4-3 Level 3 EN 61 000-4-4 Level 4 EN 61 000-4-5 Level 4 EN 61 000-4-11 compliant	
Connection	Connector H15, IEC 60 603-2 keyable		2 connectors H15, IEC 60 603-2 keyable	
Approvals LGS design-tested	IEC 950/EN 60 950/VDE 0805 Protection category I/VDE 0100 EN 61 000-4-3 interference level 10 V/m EN 61 000-4-11		IEC 950/EN 60 950/VDE 0805 Protection category I/VDE 0100 EN 61 000-4-3 interference level 10 V/m EN 61 000-4-11	

- 482.6 mm (19") module to IEC 60 297-3.
- Automatic changeover 115/230 V AC.
- All outputs are continuously short-circuit resistant.
- Overtemperature protection.
- AC-FAIL and SYSRESET signals.
- Integrated VME bus signals (AC-FAIL, SYSRESET).
- Design-tested: EN 60 950/VDE 0805 protection category I, VDE 0100.
- EMC standards EN 50 081-1 and 50 082-2.

### PE earthing contact:

Must be connected to the PE conductor of the mains supply network!

**L1/N:** Mains conductors

**L:** Load connection

**F:** Sensor connection (sense)

**0 VL:** Common ground for outputs 1 – 3.

### With sensor lead operation

**(5 V only):**

Max. voltage compensation per lead 0.25 V.

The sensor lead must be connected to the load.

### Without sensor lead operation:

For safe operation of the unit, +5 VL must be connected to +5 VF and 0 VL to 0 VF.

### Caution:

Fire protection must be provided via the superordinate enclosure system!

3U

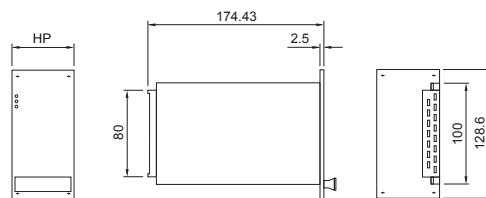

6U

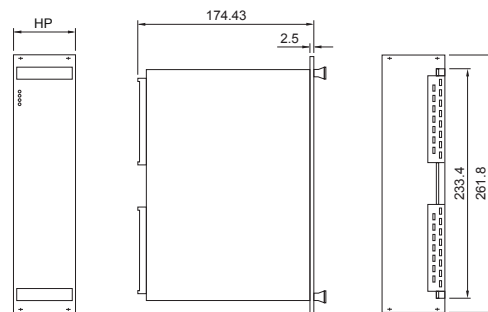

### Connector assignment H15, IEC 60 603-2 (DIN 41 612)

	3U	6U	
Pin	Function	Function (P1)	Function (P2)
4	+5 VF	+5 VL	AC-FAIL
6	0 VF	+5 VL	SYSRESET
8	+5 VF	+5 VL	assigned internally
10	0 VF	+5 VL	assigned internally
12	+5 VF	+5 VF	assigned internally
14	0 VL	+5 VF	assigned internally
16	SYSRESET	-12 VL	assigned internally
18	0 VL	0 VL	mains-related
20	+12 VL	0 VL	mains-related
22	-12 VL	0 VL	mains-related
24	AC-FAIL	0 VL	mains-related
26	assigned internally (mains-related)	0 VL	mains-related
28	L1	+12 VL	L1
30	N	+12 VL	N
32	PE	0 VF	PE

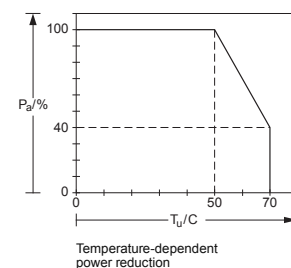
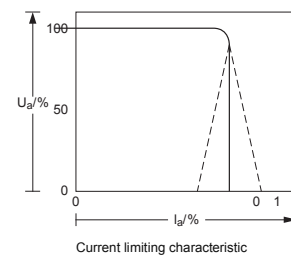

# Power supplies

## Ripac power supplies for cPCI plug-in

### General specifications

Height	3 U			6 U
Width (HP)	8 HP			8 HP
<b>Model No. RP AC power supply</b>	<b>3688.534</b>	<b>3688.694</b>	<b>3688.695</b>	<b>3688.528</b>
<b>Model No. RP DC power supply</b>	<b>3688.537</b>	<b>3688.655</b>	<b>3688.696</b>	<b>3688.530</b>
Current sharing parallel N+1 operation (redundancy)	U <sub>1</sub> , U <sub>2</sub> and U <sub>3</sub> , internal diodes, "hotswap"-compatible			
Operating temperature range	0° to 70°C (0° – 50°C full load), 50°C to 70°C, linear derating			
Cooling	Min. 15 cfm for full load			Min. 90 cfm for full load
Storage temperature	-40°C to +85°C			
Rel. humidity	< 90 % non-condensing			
Weight	approx. 1 kg			approx. 2.4 kg
MTBF	150,000 h at an ambient temperature of 25°C			
Handle	Type VII, Model No. RP 3686.135			
Guide rail	2.54 mm offset, Model No. RP 3687.832			
EMC	FCC Level B, EN 55 022 Level B (conducted)			FCC Level A, EN 55 022 Level A
Connectors	Positronic 47-pin, PICMG 2.11			
Approvals	EN 60 950 A1 – A4, CSA 22.2, UL 1950, CE			

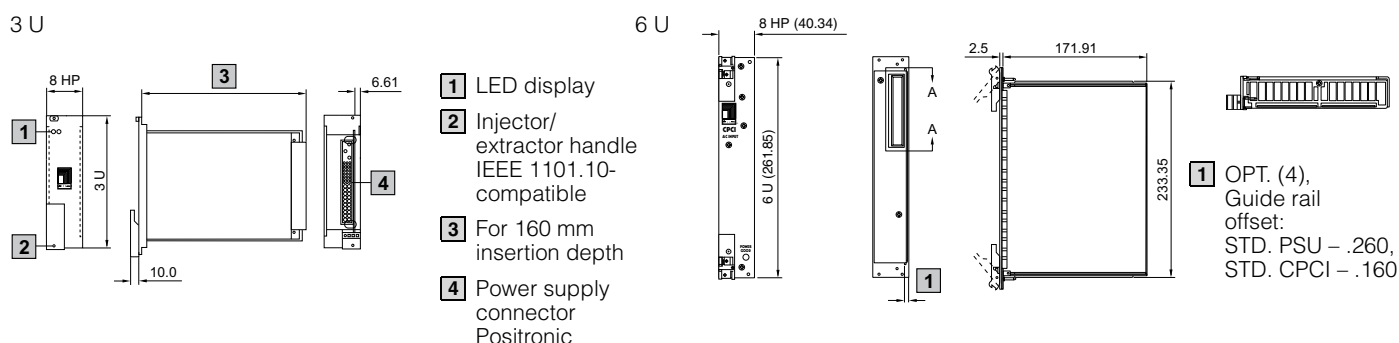

### Connector assignment 3 U

Pin#	SEQ <sup>1)</sup>	FUNCTION
01 – 04	2	+5.0 V V 1 Output
05 – 12	2	GND V 1 + V 2 Return
13 – 18	2	+3.3 V V 2 Output
19	2	GND V 3 Return
20	2	+12.0 V V 3 Output
21	2	-12.0 V V 4 Output
22	2	RTN Signal Return
23	2	N/C No Connection (Reserved)
24	2	GND V 4 Return
25, 26	2	N/C No Connection (Reserved)
27	3	R/EN Remote Enable, Close circuit to GND
28, 29	2	N/C No Connection (Reserved)
30	2	+ S 1 +5.0 V (V 1) Remote Sense
31, 32	2	N/C No Connection (Reserved)
33	2	+ S 2 +3.3 V (V 2) Remote Sense
34	2	S-RTN Sense Return for V 1, V 2, V 3
35	3	N/C No Connection (Reserved)
36	2	+ S 3 +12.0 V (V 3) Remote Sense
37	2	N/C No Connection (Reserved)
38	2	DEG Overtemperature
39	2	R/INH Remote Inhibit, Close circuit to GND
40	2	N/C No Connection (Reserved)
41	3	N/C No Connection (Reserved)
42	2	PF Power Fail Signal
43	2	N/C No Connection (Reserved)
44	3	N/C No Connection (Reserved)
45	1	PE Protective Earth (chassis) Safety Ground
46	2	ACC Neutral (N) AC Power Input/+DC Input
47	2	AC Line (L) AC Power Input/-DC Input

<sup>1)</sup>Contact mating sequence  
 1 = First to make/Last to break

### Connector assignment 6 U

Pin#	SEQ <sup>1)</sup>	FUNCTION
01 – 04	2	+5.0 V V 1 Output
05 – 12	2	GND V 1 + V 2 Return
13 – 18	2	+3.3 V V 2 Output
19	2	GND V 3 Return
20	2	+12.0 V V 3 Output
21	2	-12.0 V V 4 Output
22	2	RTN Signal Return
23	2	N/C No Connection (Reserved)
24	2	GND V 4 Return
25, 26	2	N/C No Connection (Reserved)
27	3	R/EN Remote Enable, Close circuit to GND
28	2	N/C No Connection (Reserved)
29	2	V 1-ADJ +5.0 V Remote Voltage Adjust
30	2	+ S 1 +5.0 V (V 1) Remote Sense
31	2	N/C No Connection (Reserved)
32	2	V 2-ADJ +3.3 V Remote Voltage Adjust
33	2	+ S 2 +3.3 V (V 2) Remote Sense
34	2	S-RTN Sense Return for V 1, V 2, V 3
35	3	ISHR-1 +5.0 V (V 1) Current Share
36	2	+ S 3 +12.0 V (V 3) Remote Sense
37	2	N/C No Connection (Reserved)
38	2	DEG Overtemperature
39	2	R/INH Remote Inhibit, Close circuit to GND
40	2	N/C No Connection (Reserved)
41	3	ISHR-2 +3.3 V (V 2) Current Share
42	2	PF Power Fail Signal
43	2	N/C No Connection (Reserved)
44	3	ISHR-3 +12.0 V (V 3) Current Share
45	1	PE Protective Earth (chassis) Safety Ground
46	2	ACC Neutral AC Power Input/+DC Input
47	2	AC Line AC Power Input/-DC Input

# Subracks

Key to drawings for Ripac EASY subracks

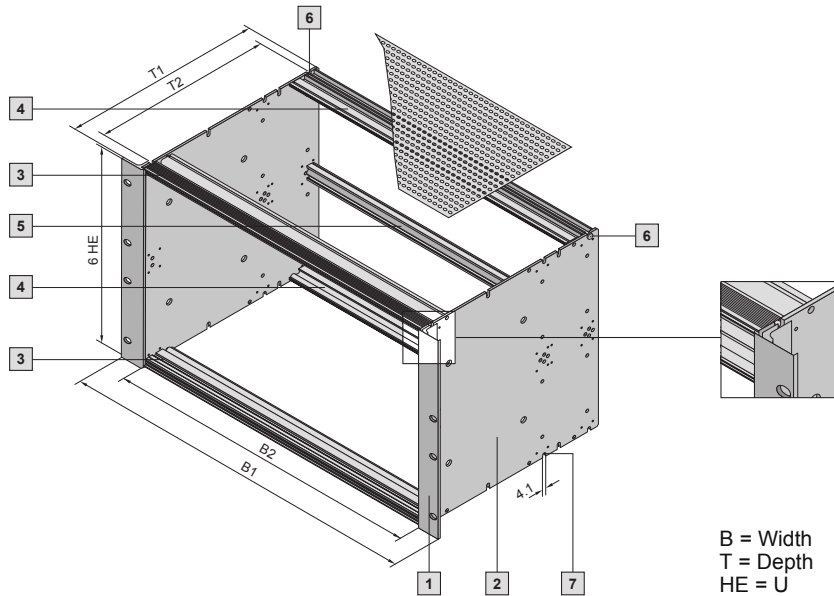

Illustrated here by the example of Ripac Vario EMC 6U

B1	482.6 mm (19")
B2	HP pitch units (at 19": 84 HP)
T1	Side panel depth
T2	Pitch
7	Mounting holes $\varnothing$ 4.1 mm for screws M4 x 12

B = Width  
T = Depth  
HE = U

## Ripac EASY 3U, 6U - supply includes

Height units U					3	6	Page
		T1 mm	T2 mm	Packs of			
2	Side panels	175	150	2	3634.695	3634.720	110
		235	210	2	3634.700	3634.725	
		295	270	2	3634.705	3634.730	
		355	330	2	3634.710	3634.735	
		415	390	2	3634.715	3634.740	
1	Flanges 3 U		3634.745	2	2	-	111
	Flanges 6 U		3634.750	2	-	2	
2	Side panels		see above	2	2	2	-
3	A2	Rails front, including threaded inserts, screws	3634.600	2	2	2	113
4	C4	Rails rear, including screws	3634.615	2	2	2	113
5	D3	Horizontal rails, rear, centre	3634.045	1	-	1	115
6		Assembly screws M4 x 12 (prefitted)	3634.430	100	8	10	159

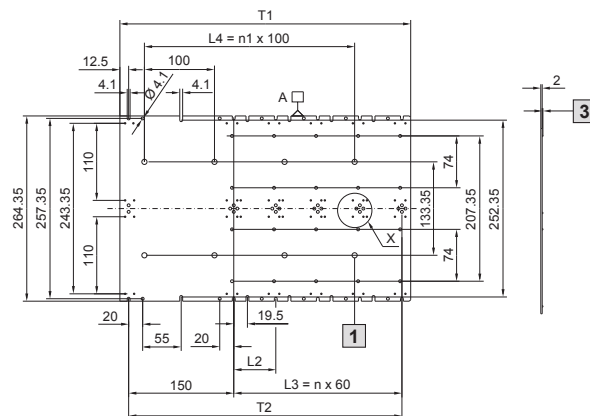
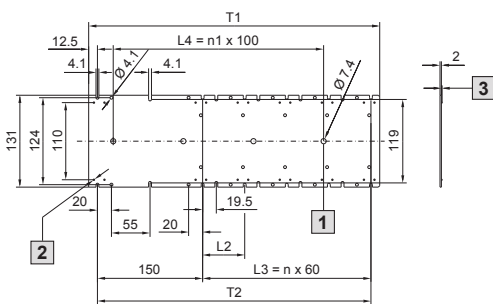

- 1 Drilled holes suitable for threaded inserts PEM-FM4-1
- 2 Half shear,  $\varnothing$  2 mm
- 3 Half shear height 1 mm

B = Width  
T = Depth

# Subracks

## Subracks

Key to all Ripac subrack drawings

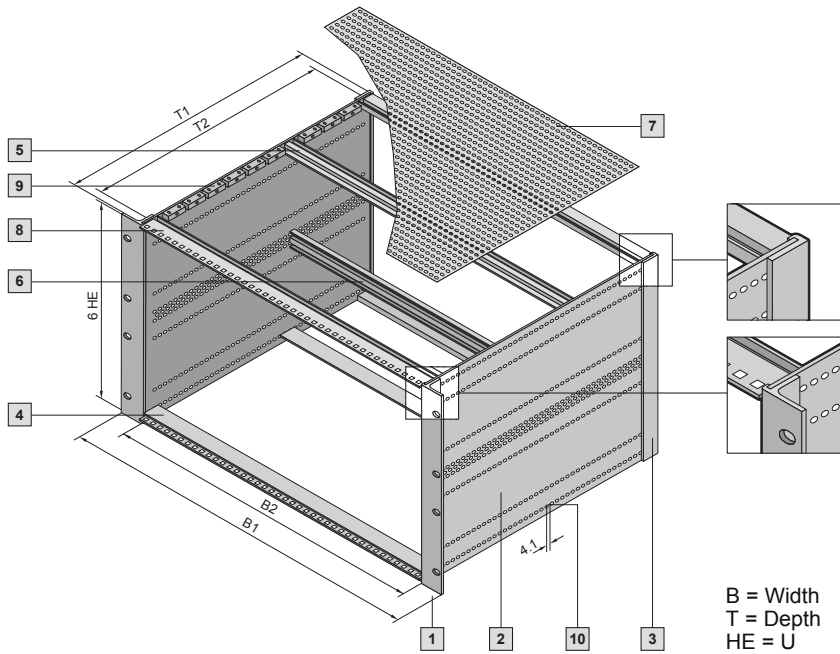

Illustrated here by the example of Ripac Vario EMC 6U

B1	482.6 mm (19")
B2	HP pitch units (at 19": 84 HP)
T1	Side panel depth
T2	Pitch
10	Mounting holes $\varnothing$ 4.1 mm for screws M4 x 12

### Ripac Vario, Ripac Vario EMC

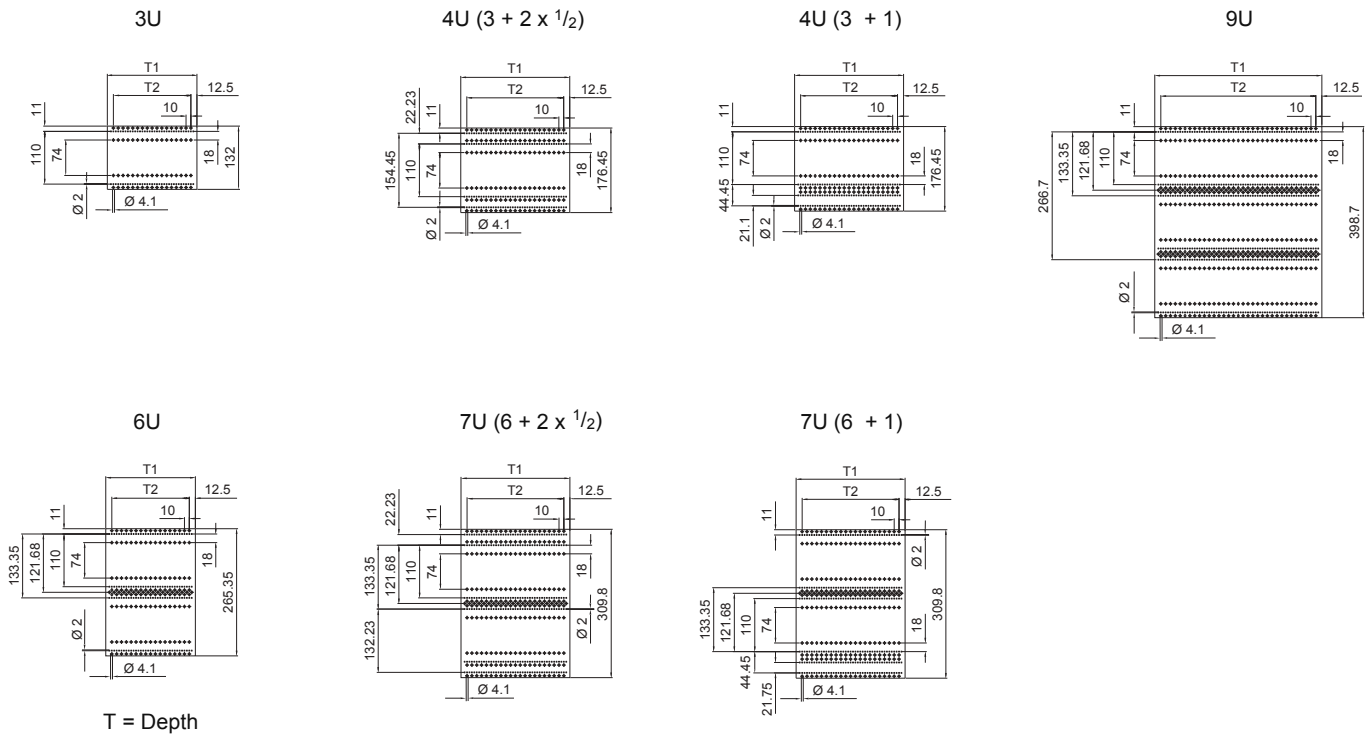



# Subracks

## Ripac Vario, Ripac Vario EMC 3U, 4U, 6U, 7U, 9U - supply includes

Height units U	T1 mm	T2 mm	Packs of	3	6	9	4 (3 + 1)	4 (3 + 2 x 1/2)	7 (6 + 1)	7 (6 + 2 x 1/2)	Page
[2] Side panels	185	160	1	3684.511	3684.529	-	-	-	-	-	110
	225	200	1	3684.512	3684.530	3685.797	3685.793	3685.890	3685.896	3685.893	
	245	220	1	3684.513	3684.531	-	3685.850	3685.891	3685.897	3685.894	
	285	260	1	3684.514	3684.532	-	3684.523	3684.526	3685.743	3685.895	
	305	280	1	3684.515	3684.533	3685.798	3685.794	-	-	-	
	345	320	1	3684.516	3684.534	3684.547	3684.524	3684.527	3685.744	3685.745	
	365	340	1	3684.517	3684.535	3685.799	3685.795	-	-	-	
	405	380	1	3684.518	3684.536	3684.548	3684.525	3684.528	3684.541	3684.543	
	425	400	1	3684.519	3684.537	-	-	-	-	-	
	465	440	1	3684.520	3684.538	3684.549	3685.796	3685.892	3684.542	3684.544	
	525	500	1	3684.521	3684.539	3684.550	-	-	3685.898	3685.959	
	585	560	1	3684.522	3684.540	3684.551	-	-	-	-	

### Subrack Ripac Vario

PT	Model No.	Packs of	BP	C	BP	C	BP	C	BP	C	BP	C	BP	C	BP	BP	Page
[1]	Flanges	-	1	3684.615	3684.617	3684.619	3684.616				3684.618				111		
[2]	Side panels	see above	1	2	2	2	2	2	2	2	2	2	2	2	2	2	110
[4] A	Horizontal rails, front	3684.562	1	2	2	2	2	2	2	2	2	2	2	2	2	2	116
I	Threaded inserts	3684.610	1	2	2	2	2	2	2	2	2	2	2	2	2	2	122
[5] C1	Horizontal rails, rear	3684.572	1	2	-	2	-	2	-	2	-	2	-	2	2	2	118
[6] D1	Horizontal rails, rear, centre	3684.582	1	-	-	1	-	2	-	-	-	-	-	1	1	1	120
G	Insulating strips 21 HP	3684.611	1	8	-	16	-	24	-	8	-	8	-	16	16	16	123
C3	Horizontal rails, rear, with Z rails	3686.159	1	-	2	-	2	-	2	-	2	-	2	-	-	-	119
D2	Horizontal rails, rear, centre, with integral Z rails	3687.602	1	-	-	-	1	-	2	-	-	-	-	-	-	-	120
[10]	Assembly screws M4 x 12	3684.881	1	8	8	10	10	12	12	8	8	8	8	10	10	-	-

### Subrack Ripac Vario EMC

PT	Model No.	Packs of	BP	BP <sup>1)</sup>	BP	BP <sup>1)</sup>	BP	BP <sup>1)</sup>	BP	BP <sup>1)</sup>	BP	BP <sup>1)</sup>	BP	BP <sup>1)</sup>	BP	BP <sup>1)</sup>	Page	
[1]	Flanges	-	1	3684.615	3684.617	3684.619	3684.616				3684.618				111			
[3]	Trim sections, rear	-	1	3684.634	3684.636	3684.638	3684.635				3684.637				112			
[2]	Side panels	see above	1	2	2	2	2	2	2	2	2	2	2	2	2	2	110	
	EMC gaskets, vertical	-	1	3686.975	3686.977	3686.979	3686.976				3686.978				124			
[7]	Covers, vented	see below	1	2	2	2	2	2	2	2	-	-	2	2	-	-	-	
	Covers, L-shaped, 1/2 U, top solid/bottom vented at front	see below	1	-	-	-	-	-	-	-	1/1	1/1	-	-	1/1	1/1	-	
[9]	Mounting blocks	3684.234	10	Depending on depth														125
K	EMC gaskets for covers	3684.245	10	4	4	4	4	4	4	4	4	2	2	4	4	2	2	125
[4] A	Horizontal rails, front	3684.562	1	4	3	4	2	4	2	6	5	4	3	6	4	4	2	116
I	Threaded inserts	3684.610	1	4	4	4	4	4	4	6	6	4	4	6	6	4	4	122
[8] B	Front horizontal rails with 10 mm extension	3684.567	1	-	1	-	2	-	2	-	1	-	1	-	2	-	2	117
[5] C1	Horizontal rails, rear	3684.572	1	2	2	2	2	2	2	2	2	2	2	2	2	2	2	118
[6] D1	Horizontal rails, rear, centre	3684.582	1	-	-	1	1	2	2	-	-	-	-	1	1	1	1	120
G	Insulating strips 21 HP	3684.611	1	8	8	16	16	24	24	8	8	8	8	16	16	16	16	123
[10]	Assembly screws M4 x 12	3684.881	1	12	12	14	14	16	16	16	16	12	12	18	18	14	14	-

### Covers for Ripac Vario EMC

Height units U	T1 mm	Packs of	3	6	9	4 (3 + 1)	4 (3 + 2 x 1/2)	7 (6 + 1)	7 (6 + 2 x 1/2)	Page
[7] Top covers	245	1		3684.695		-	-	-	-	134
	285	1		3684.696		3684.696	3684.732/3684.726 <sup>2)</sup>	3684.696	3684.732/3684.726 <sup>2)</sup>	
	305	1		3685.852		-	-	-	-	
	345	1		3684.698		3684.698	3684.733/3684.727 <sup>2)</sup>	3684.698	3684.733/3684.727 <sup>2)</sup>	
	405	1		3684.700		3684.700	3684.734/3684.728 <sup>2)</sup>	3684.700	3684.734/3684.728 <sup>2)</sup>	
	465	1		3684.701		-	-	3684.701	3684.735/3684.729 <sup>2)</sup>	
	525	1		3684.702		-	-	-	-	
	585	1		3684.703		-	-	-	-	

BP = for backplane C = for DIN connector PT = rail type  
<sup>1)</sup>Front horizontal rails with 10 mm cover for injector/extractor handles (B) <sup>2)</sup>vented/not vented

Subracks

Ripac Compact 3U, 6U - supply includes

									EMC version					Page	
Height units U				3	3	3	3	6	3	3	3	3	6		
Installation depthHP				21	21	42	42	42	21	21	42	42	42		
		T1 mm	T2 mm	Packs of	HS	MP	HS	MP	MP	HS	MP	HS	MP	MP	
2	Side panels	225	200	x	3684.512			3684.530	3684.512			3684.530			
		285	260	x	3684.514			3684.532	3684.514			3684.532			
	PT	Mounting		Packs of	For backplane										
2	Side panels		see above	x	2	2	2	2	2	1	1	1	1	1	110
	Side panels for cable entry			x	-	-	-	-	-	1	1	1	1	1	-
	EMC PG cable gland			x	-	-	-	-	-	1	1	1	1	1	-
3	Trim sections, rear			x	4	2	4	2	2	4	2	4	2	2	112
1	Flanges with keyhole			x	-	2	-	2	2	-	2	-	2	2	-
	EMC front/rear panels			x	-	-	-	-	-	-	1	-	1	1	-
	EMC rear panel for rail adaptor			x	-	-	-	-	-	1	-	1	-	-	-
	Rear panel for rail adaptor			x	1	-	1	-	-	-	-	-	-	-	-
	Rail adaptor			x	1	-	1	-	-	1	-	1	-	-	-
	EMC gaskets, vertical			x	-	-	-	-	-	2	1	2	1	1	124
7	Covers, vented		see below	x	-	-	-	-	-	2	2	2	2	2	137
4	A	Horizontal rails, front		x	4	2	4	2	2	4	4	4	4	4	116
5	C1	Horizontal rails, rear		x	2	2	2	2	2	2	2	2	2	2	118
	I	Threaded inserts		x	4	2	4	2	2	4	4	4	4	4	122
	G	Insulating strips 21 HP		x	2	2	4	4	8	2	2	4	4	8	123
6	D1	Horizontal rails, rear, centre		x	-	-	-	-	1	-	-	-	-	1	120

Covers for Ripac Compact

		LP mm	Packs of	3	3	3	3	6	3	3	3	3	6	Page	
7	Covers, vented	160	1	3687.624			3687.625			3687.624 <sup>1)</sup>			3687.625 <sup>1)</sup>		137
	Covers, vented	220	1	3687.692			3687.677			3687.692 <sup>1)</sup>			3687.677 <sup>1)</sup>		137
	F Z rails IEC 60 603-2 (DIN 41 612)		1	3684.599			3684.600			3684.599			3684.600		121

HS = top hat rail MP = mounting plate PT = rail type LP = PCB depth  
<sup>1)</sup>included with the supply

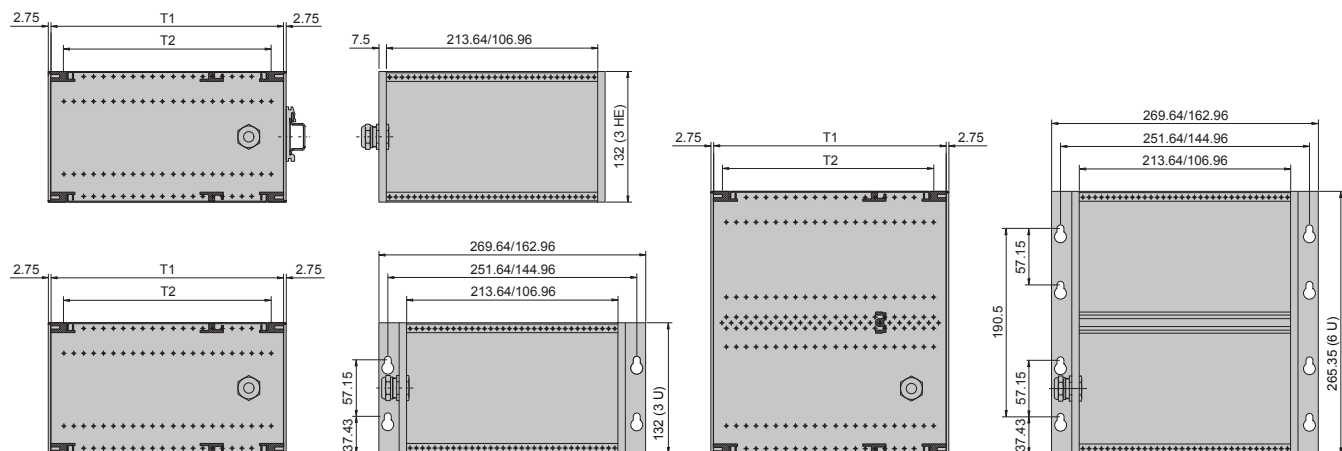
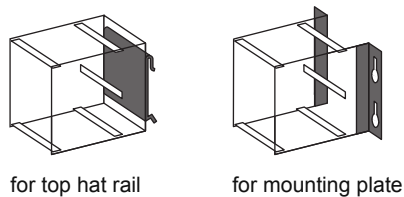

T = Depth  
 HE = U

# Subracks

## Ripac Vario Mobil 5U, 6U - supply includes

Height units U				3	3	EMC		EMC		Page
				BP	C	BP	BP	C	BP	
	T1 mm	T2 mm	Packs of	3684.513		3684.531				
2	Side panels	245	1	3684.513		3684.531				110
	PT		Model No.	Packs of						
1	Flanges	-	1	3684.615		3684.617				111
3	Trim sections, rear	-	1	-	-	2	-	-	2	112
						3684.634			3684.636	
2	Side panels	see above	1	2	2	2	2	2	2	110
	EMC gaskets, vertical	-	1	-	-	2	-	-	2	124
						3686.975			3686.977	
7	Covers, vented	3684.695	1	-	-	2	-	-	2	134
9	Mounting blocks	3684.234	10	-	-	20	-	-	20	125
	K EMC gaskets for covers	3684.245	10	-	-	4	-	-	4	125
4	A Horizontal rails, front	3684.562	1	4	4	4	4	4	4	116
	I Threaded inserts	3684.610	1	4	4	4	4	4	4	122
5	C1 Horizontal rails, rear	3684.572	1	2	-	2	2	-	2	118
6	D1 Horizontal rails, rear, centre	3684.582	1	-	-	-	1	-	1	120
	G Insulating strips 21 HP	3684.611	1	8	-	8	16	-	16	123
	C3 Horizontal rails, rear, with integral Z rails	3686.159	1	-	2	-	-	2	-	119
	D2 Horizontal rails, rear, centre, with integral Z rails	3687.602	1	-	-	-	-	1	-	120
	Assembly screws M4 x 12	3684.881	1	12	12	12	14	14	14	-
	Assembly screws M3 x 6	3684.883	1	-	-	60	-	-	60	-

BP = for backplane C = for connector DIN PT = rail type

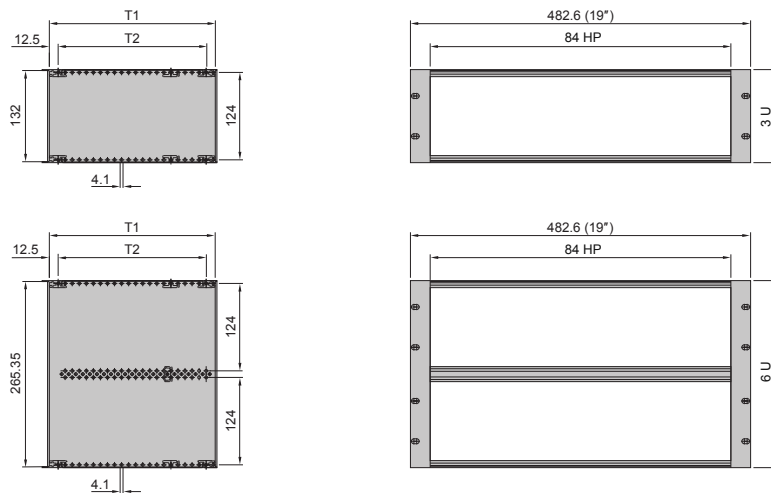

T = Depth

## Instrument cases/system enclosures

### RiBox system enclosure 1U

482.6 mm (19") rack mount

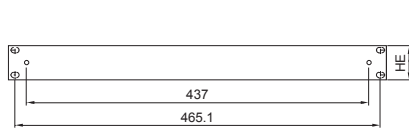

HE = U

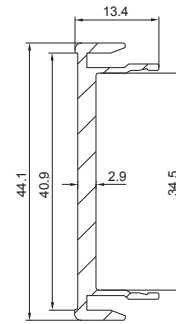
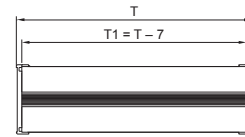
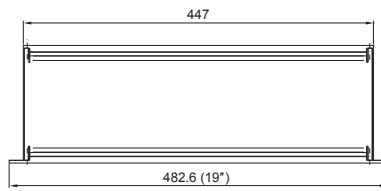

### Instrument case

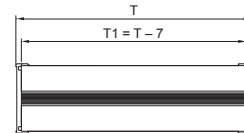
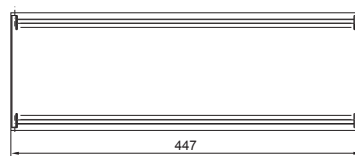
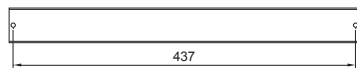

Instrument case	Model No. RP		D (T) mm
	482.6 mm (19") rack mount	482.6 mm (19") rack mount <sup>1)</sup>	
<b>3687.819</b>	<b>3687.814</b>	–	150
<b>3687.820</b>	<b>3687.815</b>	–	200
<b>3687.821</b>	<b>3687.816</b>	<b>3684.072</b>	250
<b>3687.822</b>	<b>3687.817</b>	–	300
<b>3687.823</b>	<b>3687.818</b>	<b>3684.073</b>	350

<sup>1)</sup> Including assembly kit for double Euroboards

# Instrument cases/system enclosures

## Ripac Vario-Module

2U

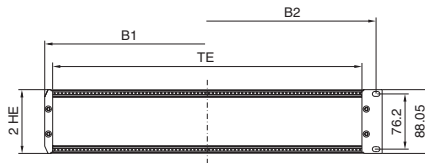
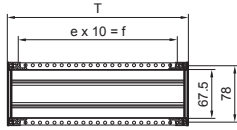

3U

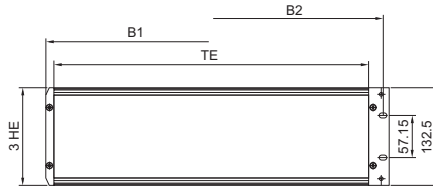
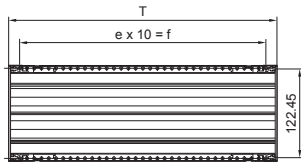

4U

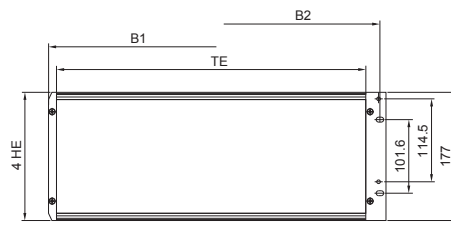
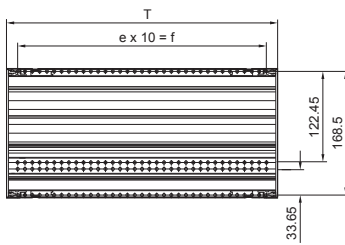

6U

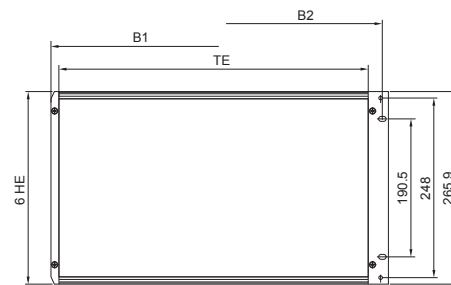
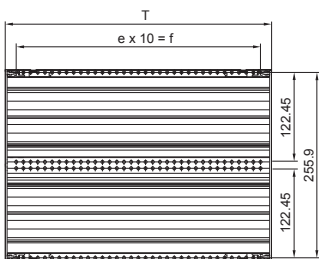

7U

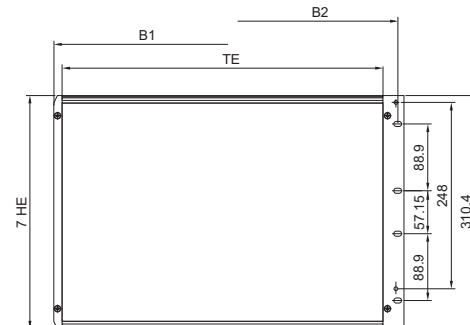
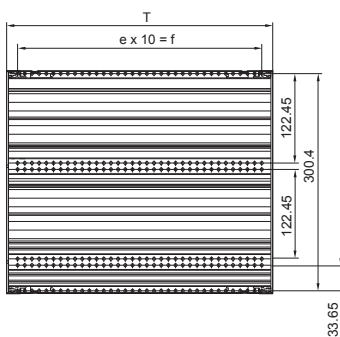

Model No. VM	U (HE)	HP (TE)	D mm	e	B1 mm	B2 mm
3982.000	2	42	250.4	22	235.6	251.6
3982.020	2	42	310.4	28	235.6	251.6
3982.290	2	63	250.4	22	342.3	358.3
3982.300	2	63	310.4	28	342.3	358.3
3982.010	2	84	250.4	22	449.0	465.1
3982.030	2	84	310.4	28	449.0	465.1
3982.040	3	42	250.4	22	235.6	251.6
3982.070	3	42	310.4	28	235.6	251.6
3982.050	3	63	250.4	22	342.3	358.3
3982.080	3	63	310.4	28	342.3	358.3
3982.060	3	84	250.4	22	449.0	465.1
3982.090	3	84	310.4	28	449.0	465.1
3982.100	3	84	370.4	34	449.0	465.1
3982.110	4	84	250.4	22	449.0	465.1
3982.120	4	84	310.4	28	449.0	465.1
3982.130	4	84	370.4	34	449.0	465.1
3982.140	6	84	310.4	28	449.0	465.1
3982.150	6	84	370.4	34	449.0	465.1
3982.160	6	84	430.4	40	449.0	465.1
3982.170	7	84	310.4	28	449.0	465.1
3982.190	7	84	430.4	40	449.0	465.1

Model No. VM (EMC)	U (HE)	HP (TE)	D mm	e	B1 mm	B2 mm
3983.000	2	42	250.4	22	235.6	251.6
3983.020	2	42	310.4	28	235.6	251.6
3983.290	2	63	250.4	22	342.3	358.3
3983.300	2	63	310.4	28	342.3	358.3
3983.010	2	84	250.4	22	449.0	465.1
3983.030	2	84	310.4	28	449.0	465.1
3983.040	3	42	250.4	22	235.6	251.6
3983.070	3	42	310.4	28	235.6	251.6
3983.050	3	63	250.4	22	342.3	358.3
3983.080	3	63	310.4	28	342.3	358.3
3983.060	3	84	250.4	22	449.0	465.1
3983.090	3	84	310.4	28	449.0	465.1
3983.100	3	84	370.4	34	449.0	465.1
3983.110	4	84	250.4	22	449.0	465.1
3983.120	4	84	310.4	28	449.0	465.1
3983.130	4	84	370.4	34	449.0	465.1
3983.140	6	84	310.4	28	449.0	465.1
3983.150	6	84	370.4	34	449.0	465.1
3983.160	6	84	430.4	40	449.0	465.1
3983.170	7	84	310.4	28	449.0	465.1
3983.190	7	84	430.4	40	449.0	465.1

B = Width  
T = Depth

# Subracks

RiCase 269.2 mm (1/2 19")  
RiCase 482.6 mm (19")

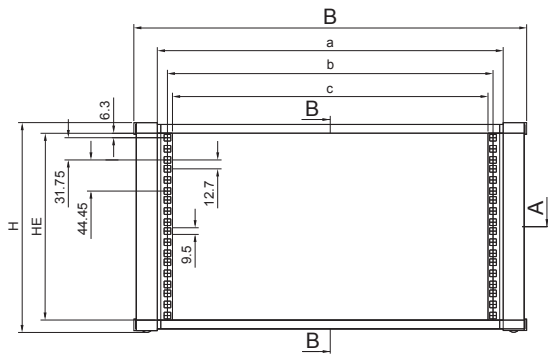

Section B – B

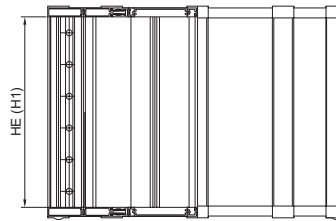

Detail X

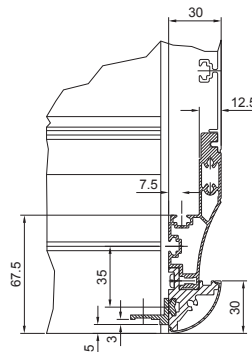
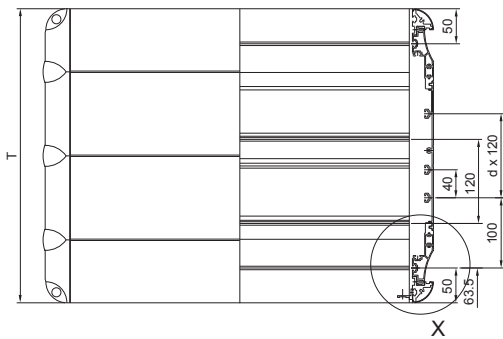

**RiCase 269.2 mm (1/2 19")**

not vented									
Model No. RC, RAL 5018	3750.100	–	3750.200	–	3750.210	3750.300	–	3750.400	–
Model No. RC, RAL 5012	3750.102	–	3750.202	–	3750.212	3750.302	–	3750.402	–
Model No. RC, RAL 7030	3750.104	–	3750.204	–	3750.214	3750.304	–	3750.404	–
vented									
Model No. RC, RAL 5018	–	3750.110	–	3750.220	–	3750.350	3750.360	–	3750.450
Model No. RC, RAL 5012	–	3750.112	–	3750.222	–	3750.352	3750.362	–	3750.452
Model No. RC, RAL 7030	–	3750.114	–	3750.224	–	3750.354	3750.364	–	3750.454
U	1		2		3			4	
Width (B) mm	348.6	348.6	348.6	348.6	348.6	348.6	348.6	348.6	348.6
Height (H) mm	77.5	77.5	121.9	121.9	166.4	166.4	166.4	210.8	210.8
H1 (U) mm	45.0	45.0	89.4	89.4	133.8	133.8	133.8	178.3	178.3
Depth (T) mm	300.0	420.0	300.0	540.0	300.0	420.0	540.0	420.0	540.0
a	280.6	280.6	280.6	280.6	280.6	280.6	280.6	280.6	280.6
b	251.6	251.6	251.6	251.6	251.6	251.6	251.6	251.6	251.6
c	237.2	237.2	237.2	237.2	237.2	237.2	237.2	237.2	237.2
d	–	1	–	2	–	1	2	1	2

**RiCase 482.6 mm (19")**

not vented													
Model No. RC, RAL 5018	3750.310	3750.320	3750.410	3750.420	3750.600	3750.610	3750.620	3750.700	3750.710	3750.900	3750.910	3750.000	
Model No. RC, RAL 5012	3750.312	3750.322	3750.412	3750.422	3750.602	3750.612	3750.622	3750.702	3750.712	3750.902	3750.912	3750.002	
Model No. RC, RAL 7030	3750.314	3750.324	3750.414	3750.424	3750.604	3750.614	3750.624	3750.704	3750.714	3750.904	3750.914	3750.004	
vented													
Model No. RC, RAL 5018	3750.330	3750.340	3750.430	3750.440	3750.630	3750.640	3750.650	3750.720	3750.730	3750.920	3750.930	3750.030	
Model No. RC, RAL 5012	3750.332	3750.342	3750.432	3750.442	3750.632	3750.642	3750.652	3750.722	3750.732	3750.922	3750.932	3750.032	
Model No. RC, RAL 7030	3750.334	3750.344	3750.434	3750.444	3750.634	3750.644	3750.654	3750.724	3750.734	3750.924	3750.934	3750.034	
U	3		4		6			7		9			12
Width (B) mm	562.0	562.0	562.0	562.0	562.0	562.0	562.0	562.0	562.0	562.0	562.0	562.0	
Height (H) mm	166.4	166.4	210.8	210.8	299.7	299.7	299.7	344.2	344.2	433.1	433.1	566.5	
H1 (U) mm	133.8	133.8	178.3	178.3	267.2	267.2	267.2	311.7	311.7	400.6	400.6	534.0	
Depth (T) mm	300.0	420.0	300.0	420.0	300.0	420.0	540.0	420.0	540.0	420.0	540.0	540.0	
a	494.0	494.0	494.0	494.0	494.0	494.0	494.0	494.0	494.0	494.0	494.0	494.0	
b	465.0	465.0	465.0	465.0	465.0	465.0	465.0	465.0	465.0	465.0	465.0	465.0	
c	450.6	450.6	450.6	450.6	450.6	450.6	450.6	450.6	450.6	450.6	450.6	450.6	
d	–	1	–	1	–	1	2	1	2	1	2	2	



# EMC diagram for Ripac Vario EMC

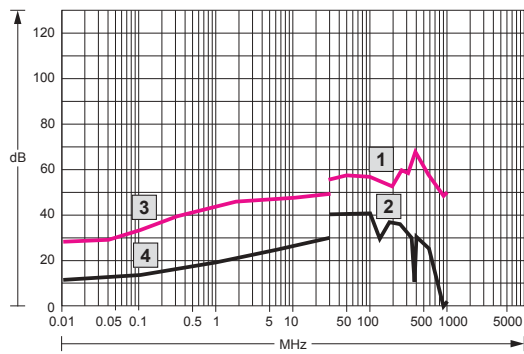

MHz = frequency  
dB = RF attenuation

- 1 E field = electrical field [V/m] EMC enclosures
- 2 E field standard enclosures
- 3 H field = magnetic field [A/m] EMC enclosures
- 4 H field standard enclosures

# PRODUCTS YOU CAN RELY ON

---

Pixus combines a superb combination for the best of 3 worlds. We incorporate German design engineering for precise components and creative, modular design.

Our manufacturing is in Asia, Europe, and N. America which we utilize depending on the product and most cost-effective solution for you.

Our FAEs, sales engineers, and management are among the most knowledgeable in the business. This provides you with experienced team members who can help you improve your packaging design, simplify your process, and save you time and money.

Overall, you get fast and knowledgeable service, a cost-effective price and design, and a quality, reliable product.



PICMG is a consortium of companies who collaboratively develop open specifications for high performance telecommunications and industrial computing applications. The members of the consortium have a long history of developing leading edge products for these industries.

PICMG, its specifications, activities, and technologies (such as AdvancedTCA, MicroTCA, CompactPCI, COM Express, and HPM) are covered extensively by PICMG Systems & Technology magazine, available in print and online at [www.picmg.com](http://www.picmg.com)

## OUR PARTNERS

Pixus Technologies has several key partners to provide our customers with best-of-class embedded computing solutions and enclosures.

Our approach is to utilize our extensive experience in embedded systems to configure the right solution to meet and exceed your performance requirements within your budget constraints.

With our strong background in the industry, we are able to select the right partner products for your application, avoiding the potential pitfalls in the process.



VadaTech is a board level design and manufacturing company focused on quick-turn designs for the embedded market. Vadatech is dedicated to introducing leading edge technology for the most demanding applications, and differentiates with extraordinary capability to rapidly create new designs in response to complex customer requirements.

Vadatech's continued service to the aerospace and telecommunications markets results in a rapidly growing product line including solutions for processing, communication, storage, and platform interoperability. [www.vadatech.com](http://www.vadatech.com)



Rittal manufactures the world's leading industrial and IT enclosures, racks and accessories, including high efficiency, high density climate control and power management systems for industrial, data center, outdoor and hybrid applications.

Rittal's off-the-shelf standard, modified standard and custom-engineered products are known throughout the world as high quality, affordable solutions for practically any industrial or IT infrastructure application-from single enclosures to comprehensive systems. [www.rittal.com](http://www.rittal.com)

**Pixus Technologies**

50 Bathurst Dr.  
Waterloo, Ontario N2V 2C5  
Phone: 519 885 5775  
Fax: 226 444 0225  
sales@pixustechnologies.com  
info@pixustechnologies.com

East Coast Sales Office  
Smithtown, NY  
Phone: 631 360 1257

West Coast Sales Office  
Sacramento, CA  
Phone: 916 297 0020

