



Pixus Technologies Products & Services



OpenVPX, SOSA-Aligned, & Specialty Enclosure Systems

- Chassis Platforms
- Backplanes
- Components
- Subsystem Integration

ABOUT PIXUS TECHNOLOGIES

Pixus designs and manufactures MIL rugged and commercial enclosure systems for the embedded computing market. The company specialized in COTS solutions for OpenVPX / SOSA™ as well as other modular open standard architectures including AdvancedTCA, MicroTCA, VME, CompactPCI Serial, PXIe, and more.



Rittal building in Asia

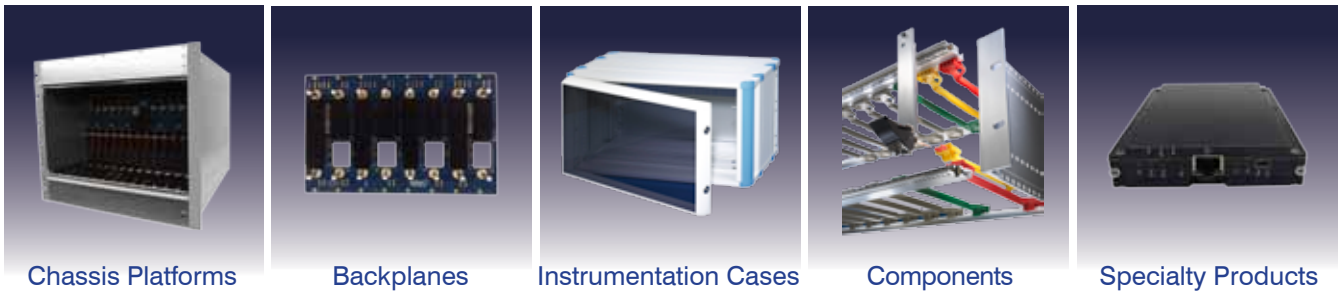

Chassis Platforms

Backplanes

Instrumentation Cases

Components

Specialty Products

- Manufacturing/integration in Canada, USA, Asia, and Europe
- Superior, dedicated service
- Excellent quality & reliability
- Nimble approach means best & most cost-effective solution
- Engineering expertise in electrical, mechanical, and integration
- Privately owned
- Established 2010 at HQ in Waterloo, Ontario (Canada's Technology Corridor)
- ISO9001:2015 and ITAR registered



ISO9001



ITAR/CGP



VITA



PICMG



SOSA

SOSA ALIGNED PRODUCTS

Pixus is a leader in OpenVPX backplane & chassis platforms for your SOSA aligned and VICTORY/HOST/CMOSS application. Our modular products and vast array of designs greatly reduces lead-time, cost, and risk for your system requirement.

The backplane for a SOSA system is essentially just a collection of Slot Profiles included in the latest specification. Pixus has developed a wide array of configurations utilizing the common SOSA profiles such as the ones with the suffix of 14.6.11, 14.6.13, 14.9.2, 14.4.14, 14.2.16, and many more.

Example SOSA slot profile

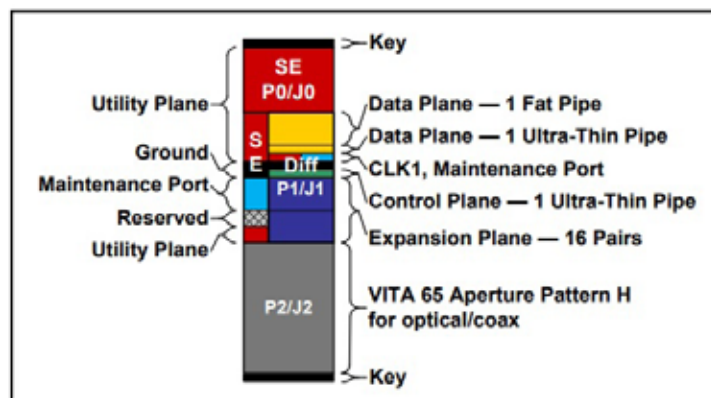

Figure 14.6.11-1 SLT3-PAY-1F1U1S1S1U1U2F1H-14.6.11-n

Pixus has SOSA aligned hardware chassis management cards in a mezzanine format that attach to the rear of the backplane without sacrificing a slot. With extensive experience in 100GbE and PCIe Gen4/5 backplane design, powerful cooling solutions, and chassis management, Pixus has a solution for you.



Backplanes



Chassis Platforms



Chassis Hardware Manager
& Specialty Products

RUGGED DESIGN

“VERSATILE, RUGGED & PROVEN”

Pixus offers a wealth of MIL rugged 19” rackmount and ATR designs for deployable applications. This includes OpenVPX / SOSA versions for the leading-edge 100GbE speeds and high wattage boards demanding superior cooling. Pixus offers air, conduction, heat exchange with fans, air flow through (VITA 48.8), Air Flow by (VITA 48.7), liquid cooled through sidewalls and VPX REDI Liquid Flow Through Module Cooling (VITA 48.4).

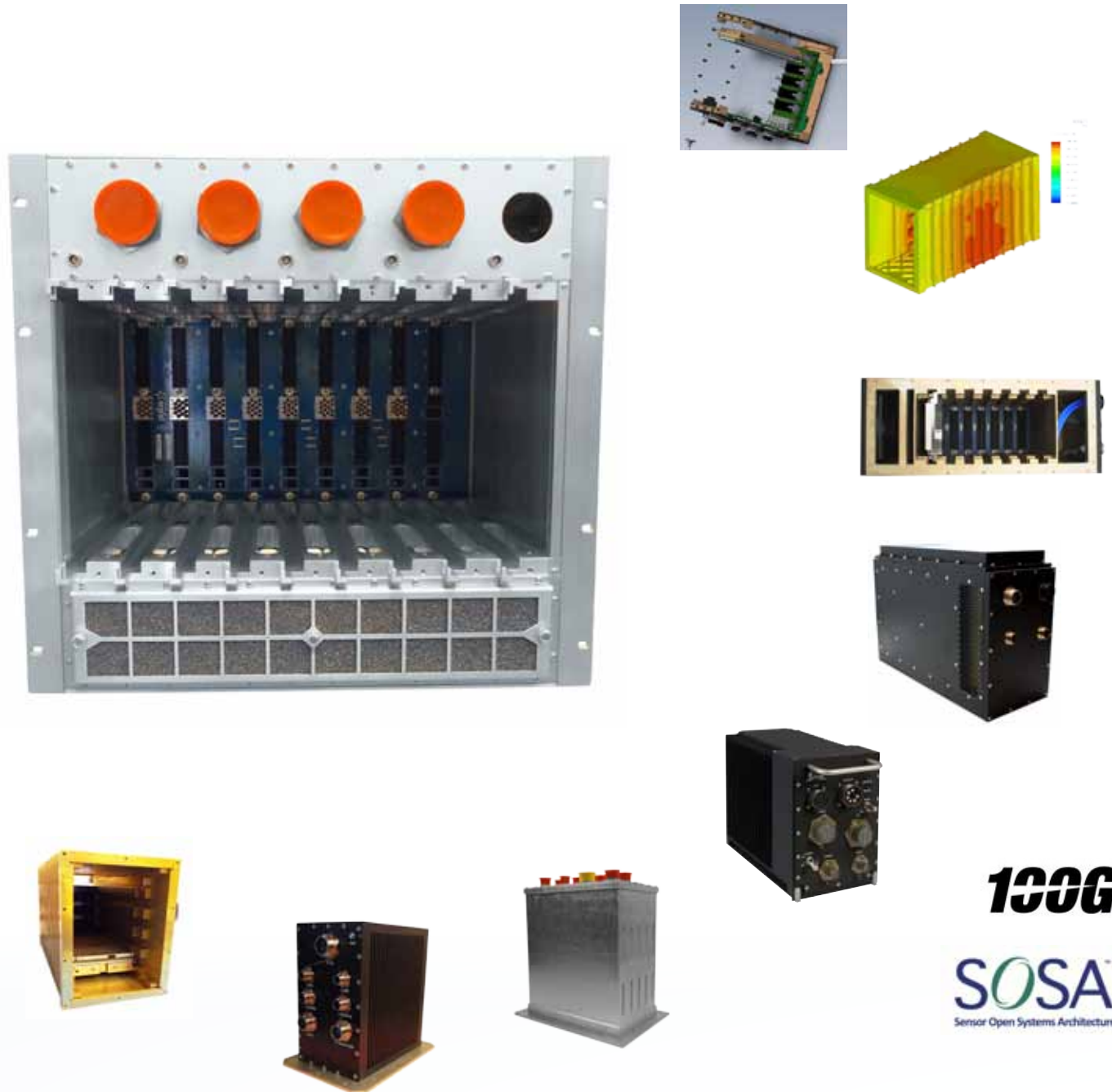

RUGGEDIZED NI SOFTWARE DEFINED RADIOS

Pixus offers ruggedized versions of NI's Ettus Research™ brand of USRP Software Defined Radios (SDRs). These tunable transceivers are an ideal product to prototype wireless communications, and to develop and deploy EW / SIG-INT applications and wireless systems.

The ruggedized SDRs can be used in various outdoor, MIL Rugged and other applications that require enhancement for shock/vibration, water/dust/sand protection, extreme temperatures, and more.

Applications

- Wideband Spectrum Monitoring
- Drone Detection/Deterrence
- Signals Intelligence
- Electronic Warfare
- Passive RADAR
- Advanced Wireless Prototyping
- Massive MIMO Testbeds
- AIS Coastal Monitoring
- Multi-channel Decoding
- NarrowBand IoT Base Station



RX310



RX410



RB210



RN310

Air Cooled	IP67 Weather Resistant	MIL Rugged
Used in often a controlled environment (19" rackmount) that requires higher shock and vibration than the standard NI enclosure	Used in applications where could be exposed to harsh environments, typically either temporary conditions or covered or in an enclosed area.	Used in rugged applications where MIL 810 for shock and vibration and MIL 461 for EMI are required.
Supports advanced cooling options, transport grade ruggedization, and other requirements.	Pixus can provide "roof cover", pole-mount, and other accessories.	The 38999 connector interfaces are utilized, typically airborne, shipboard, or vehicle-mounted defense applications.

All units typically can run in -5C to 50C environments. With an external MIL/IP67 fan and internal heater, they can support -40C to + 71C environments. Consult factory for details.

CHASSIS PLATFORMS

“MODULAR DESIGN FOR VIRTUALLY UNLIMITED CONFIGURATIONS”

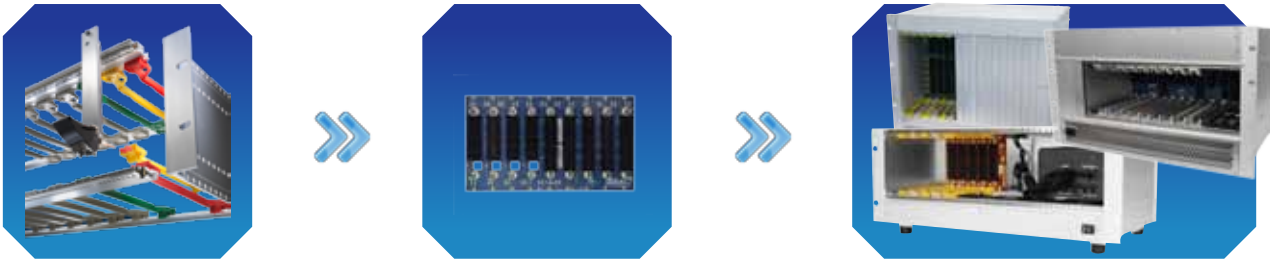

The Pixus modular design approach allows a wide range of tailored chassis configurations utilizing COTS standard parts. Our comprehensive experience in OpenVPX designs, including versions aligned with the SOSA technical standard, make Pixus the preeminent choice for high-performance chassis platforms:

- OpenVPX, CMOSS, HOST, and SOSA Aligned solutions
- Optical, RF, and VITA 66/67 interface expertise
- Cooling solutions in forced air, conduction, Air Flow Through (VITA 48.8), Air Flow by (VITA 48.7), liquid cooled (VITA 48.4), and hybrid solutions
- SOSA aligned VITA 46.11 chassis hardware managers, mezzanine and pluggable designs
- Commercial and MIL Rugged designs
- Other backplane architectures including AdvancedTCA, MicroTCA, cPCI Serial, VME, and more
- MIL testing & certification services available



Horizontal Mount OpenVPX designs,
3U/6U Hybrid Options



Dual 3U Segment for OpenVPX,
3U/6U Hybrid Options

CHASSIS PLATFORMS - CONTINUED

“ADVANCED COOLING SOLUTIONS”



Pixus offers some of the most powerful cooling solutions in the industry. The patented RiCool™ technology provides an efficient design of hot-swappable fans that reside directly above the card cage and blow the heat 90 degrees out the back of the system. This allows the use of RTMs (Rear Transition Modules) while providing advanced cooling in minimal chassis rack height. Pixus also provides thermal simulation services.



VITA 48.8 Air Flow Through
Module Card Guide Tray

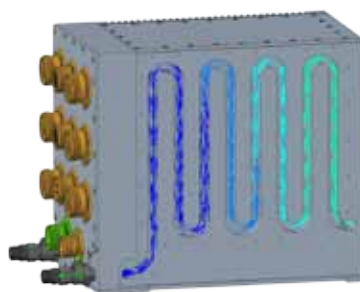

VITA 48.4 and Liquid
Through Sidewalls Solutions

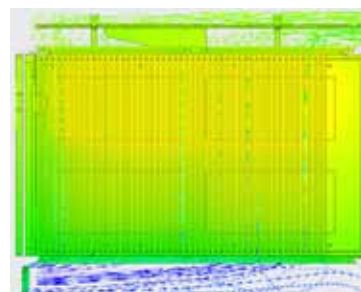

Thermal Simulation for
Optimal Cooling Solution

FAST PROTOTYPING

“HIGH VERSATILITY, FAST DELIVERY”

The Pixus open frame chassis are ideal for testing and development of SOSA / OpenVPX systems. The power and ground only backplane offers maximized versatility for prototyping. The backplane is often used in conjunction with Meritec® VPX cabling for a highly versatile approach with optional VITA 67.x and/or VITA 66.x interfaces. Versions with dual depths (160mm/220mm boards) for SpaceVPX™ and options with removable sidewalls are also available.



BACKPLANES

“HIGH-PERFORMANCE DESIGN SPECIALISTS”

Pixus specializes in high-performance backplane design, including speeds to PCIe Gen4, 100GbE, and beyond! Our wide range of standard and customizable OpenVPX / SOSA slot profile configurations includes various versions with VITA 66.x and 67.x interfaces. Backplane simulation services are also available.

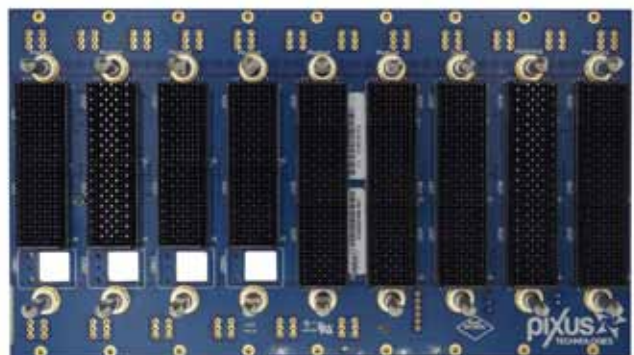
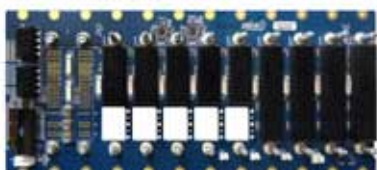
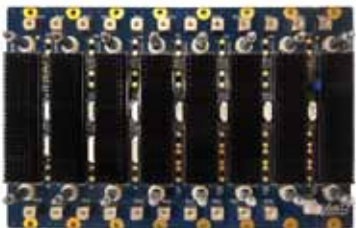

SOSA ALIGNED CHASSIS HARDWARE MANAGER

“COMPACT, VERSATILE, AND PROVEN”

Designed to the latest SOSA and VITA requirements, the chassis hardware management cards can interface with all Field Replaceable Units (FRUs) in the system. This allows sequential power-ups, graceful shutdowns, monitoring & control, and more. They also can monitor and manage power supplies and fans in the system. The mezzanine-based version plugs into the rear of a backplane so that a slot does not need to be consumed. Alternatively, pluggable versions are available. Contact Pixus for various sizes and configurations that are available.

Pixus offers chassis hardware management cards in multiple configurations with a versatile PolarFire FPGA. As a member of the hardware committees, Pixus will ensure our Tier 3+ chassis managers meet all SOSA requirements. Additionally, peripheral modules to the management cards provide supplemental features.



SHM300 Mezzanine-based Tier 3+ SOSA chassis manager



Rear View



Pluggable Chassis Manager Card

Key Features:

- SlotSaver design, attaches to rear of backplane without sacrificing a slot
- Versatile and configuration design to meet a wide range of applications
- SHM300 and SHM301 with 16-24 MP port options
- Based on versatile PolarFire FPGA
- Ability to connect to other Pixus devices for advanced features



Software/Firmware Developed
100% in the US

“SPACE-READY, RUGGED, AND PROVEN”

Whether it's a development chassis platform or a LEO/Space deployable enclosure, Pixus has a solution for you. The company offers 3U and 6U open frame test enclosures that accept both 160mm deep and/or 220mm deep boards for SpaceVPX. Pixus also has card guides for VITA 78 boards in both depths as well as the typical VITA 48.2 versions.

Pixus has developed various 3U and 6U SpaceVPX and OpenVPX ATR enclosures in various sizes and configurations. The company also has developed a variety of backplanes for SpaceVPX and VITA 78, including versions utilizing the KVPX connector for extreme shock and vibration.



KVPX Backplanes and Specialty Products:

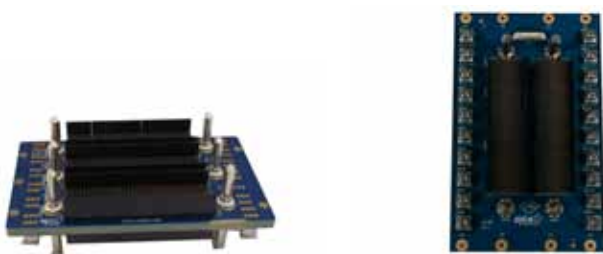

Pixus has developed specialty test boards and backplanes for VITA 63 and KVPX solutions. These designs are designed for extreme shock and vibration levels. Contact Pixus for more details.

COMPONENTS

“HIGHEST RELIABILITY, STRONG AND PRECISE”

No breaking handles!

Rugged rails that don't bend or crack!

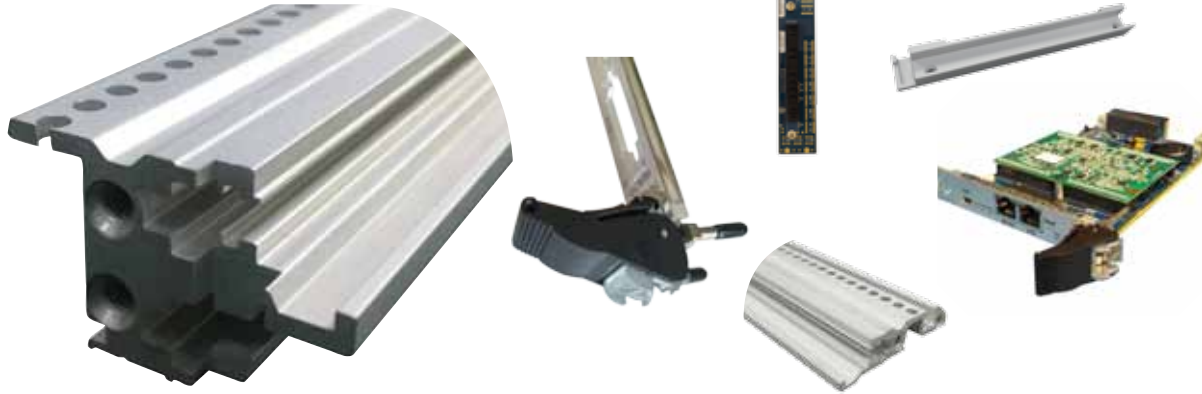

Our vast array of embedded system chassis platform components in the Eurocard format includes a complete line of components designed specifically for OpenVPX. This includes specialty card guides, panels/filler panels, threaded inserts, rugged rails, and more! The Pixus rugged rail is designed for the high insertion forces of OpenVPX. Our injector/ejector handles feature a rugged metal engagement claw that prevents wear or cracking.

INSTRUMENTATION CASES

“MODULAR VERSATILITY & STYLE”

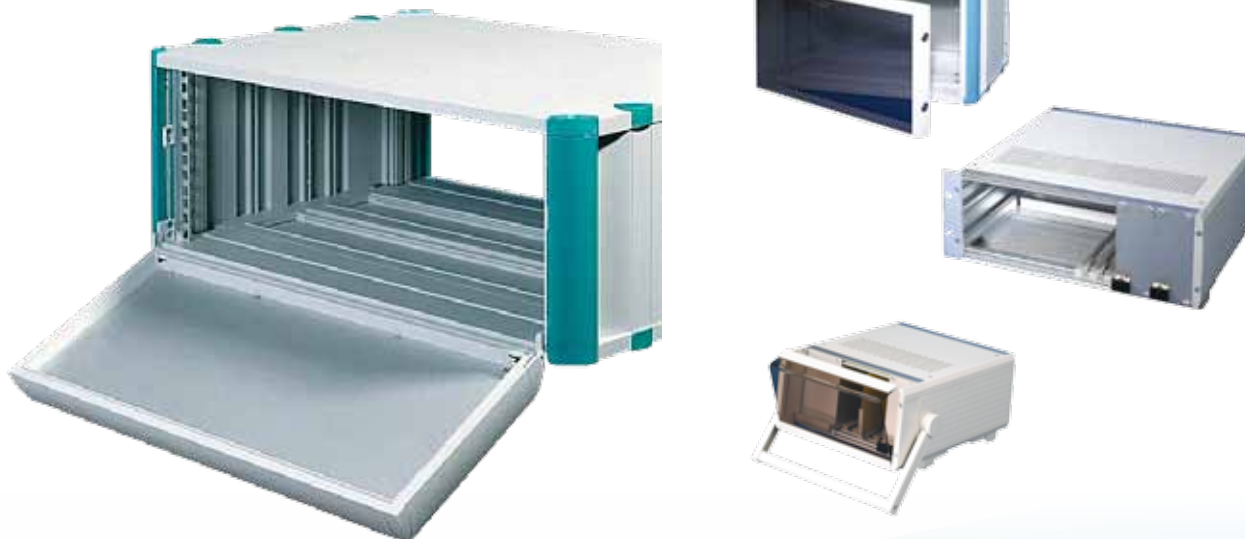

We offer a vast array of Rittal brand modular electronics enclosures in premier RiCase and versatile Vario styles.

The modular approach allows a wide range of standard heights (1U-12U), widths (19", 9.5", other), and depths (150mm to 540mm). Rugged Vario Mobile/Railway versions are available.

- Medical
- Energy/Industrial
- Test/Measurement
- Communications
- Defense



Pixus Technologies - Corporate Headquarters
50 Bathurst Dr.
Waterloo, Ontario, Canada N2V 2C5
Phone: 519 885 5775
sales@pixustechnologies.com
www.pixustechnologies.com



Pixus Technologies USA Corporation - US Distribution Center
600 Main Street, Suite 216
Tonawanda, New York 14151-0888
Phone: 916-297-0020
info@pixustechnologies.com



East Coast USA
Marietta, GA
Phone: 470 209 4467



Central and Western USA, International
Sacramento, CA
Phone: 916 297 0020



www.pixustechnologies.com

